

TOOL DESIGN

Electronic tools & Hand tools

SPECIALIZED PRODUCTS

Precision Screwdriver / Drill / Ratchet / Bits / Motherboard Tools

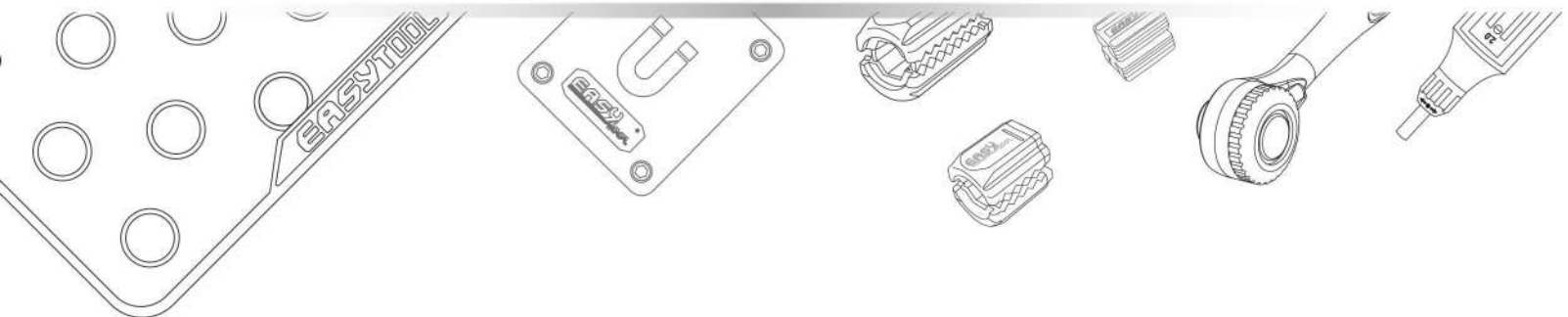

Easy Tool Enterprise Co., Ltd.

Which is located in Taichung City, central Taiwan, has been specialized in production and development of screwdrivers and bits with good reputations in the global market.

With a history over 30 years, Easy Tool is a seasoned maker in the line

Turning out a variety of screwdrivers, including precision screwdrivers, magnetic screwdrivers, one-touch screwdrivers, jewelry precision screwdrivers, screwdrivers with LED lights, screwdriver bits with different specifications, torque drivers, hammer drivers, ratchet tools and hand tool sets. All the products have been well received in European and Japanese market.

The company's tools are available in various materials

Such as S2 steel, chrome, molybdenum and other special metals for custom designs and functions. To secure consistent product quality, the company has also built a full line of VDE equipment to have its product tested for temperature endurance, pull force and durability. Plus, the company is also reputed as a reliable OEM and ODM in line.

CONTENTS

1

ETE ELECTRONIC SERIES04



2

MAGNET SERIES06

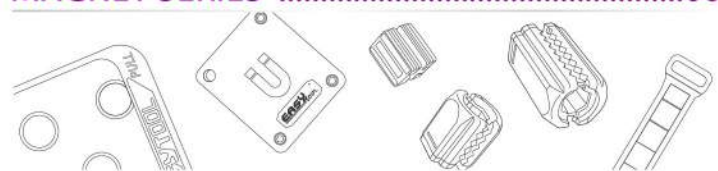

3

1/4" SCREWDRIVER08

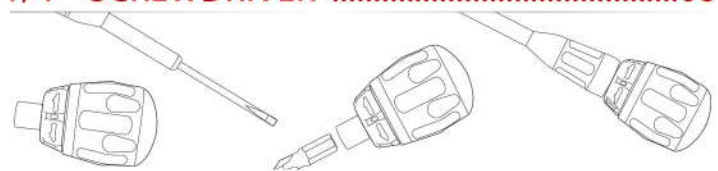

4

ALUMINIUM RATCHET TOOL SET13



5

PRECISION SCREWDRIVER22



6

TRADITIONAL SCREWDRIVER SET41

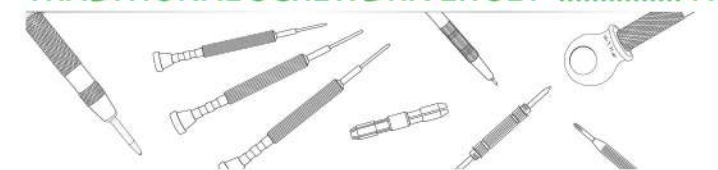

ET-01



DIGITAL TORQUE BAR

PORTABLE TORQUE BAR WITH LCD DIGITAL DISPLAY



LCD & Buzzer Alarm

APPLY ON
SCREWDRIVER
HANDLE

LOW BATTERY DISPLAY(<15%)

SPECIFICATION

Model No.	ET-01
Accuracy	±4% (<2 Nm), ±2% (2-10 Nm)
Drive Size	1/4"
Range	0.5 - 10 Nm
Display resolution	0.1
Unit selection	N-m, l-lb, kgf.cm
Size	150 x 18.8 x 18.8 mm
Weight	67g

BICYCLE
PART ADJUSTMENT

BATTERY & CHARGING

BATTERY

3.7V,300mAh
rechargeable
lithium-ion battery

CHARGING TIME

Approximately
2 hours(full charge)

STANDYBY TIME



Up to 1 year

AUTO POWER OFF

After 3 minutes
of inactivity

BATTERY CAPACITY

5 min
per cycleup to
120 uses

**EXCELLENT
QUALITY**

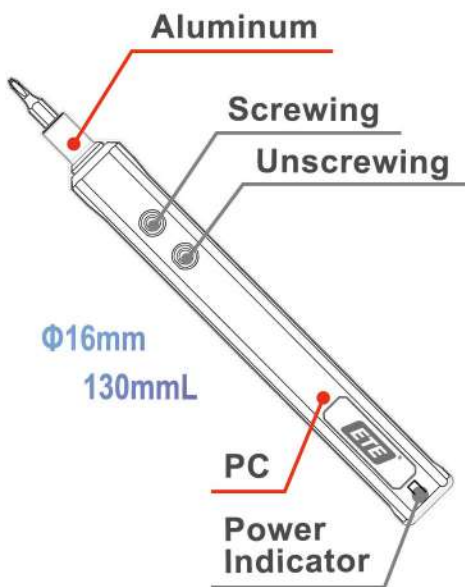

Electronic parts repair



Magnetic bit holder



Standable bit holder



ED-01 E DRIVER

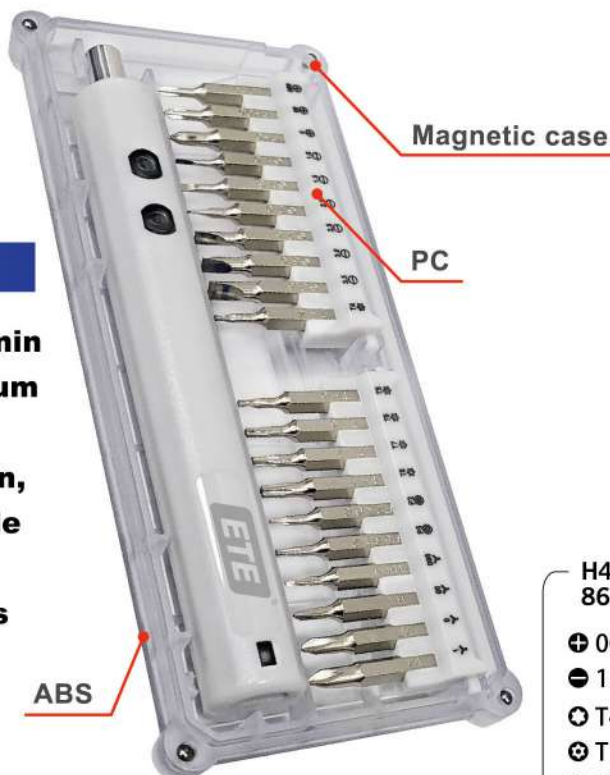
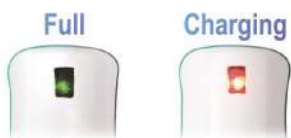

FEATURES

- **Torsion: 0.1-3 Nm, Speed: 113 r/min**
- **3.6V 220 mAh rechargeable lithium battery**
- **With a compact pen-shape design, which is easy to grip and portable**
- **20 pcs high quality Chromium-Molybdenum steel bits**
- **Ideal for repairing iPhone series, Macbook, Switch, toy, watch, gaming controller, and electronic devices**
- **Enable to use while charging**

H4*28mm Bit x 20pcs
8660(SNCM)

- ⊕ 000 / 00 / 0
- ⊖ 1.0 / 1.5 / 2.0 / 2.5 / 3.0 / 3.5
- ⊗ T4 / T5 / T6 / T7
- ⊕ TH8
- ⊗ P2 / P5
- ⊖ Y000 / Y00 / Y0 / Y1

KM-1063MT

MEGA MAT Magnetic tool mat



SIZE : 250x180x8mm

Material: Silicone / N35 Magnet
Packing : Color Box

Color Box Size : 283(L)x185(W)x18(H)mm
25 PCS/CTN 13.5/14.5 KGS - 1.2'



8mm thick



Flexible



Easy to take off



Strong Magnetism



Oil Resistant



Water Resistant

KM-1063P

MAGPAD



MAX 1.5kg

Feature

Strong Neodymium N35 magnets firmly hold your tools, such as wrenches, bits, hex key, screwdriver, hammers, etc.

Material : TPR / N35 Magnet
Packing : Card Sleeve+OPP Bag

Card Size : 160(L)x 58(W)mm
50 PCS/INNER - 250 PCS/CTN 11.4/12.4 KGS - 1'



KM-1063W

MAGSTRAP



TPE

Magnetism on both sides ↑

Feature

The wristband have embedded magnets that can securely hold small metal objects like screws, nails, nuts, bolts, and other small tools.

Material : TPE / N50 Magnet
Packing : Card+OPP Bag

Card Size : 75(L)x 120(W)mm
25 PCS/INNER 200 PCS/CTN 10/11 KGS - 1.9'



PATENTED
PATENTED
PATENTED

TAIWAN - NO. 1721761
JAPAN - NO. 6931104
GERMANY - NO. 10 2020 125 778
CHINA PATENT
U.S. PATENT

N50
Strong Powerful



KM-1063T
SHARK MAGNETIZER

KM-1063M
MINI MAGNETIZER

KM-1063MS
MINI MICRO MAGNETIZER

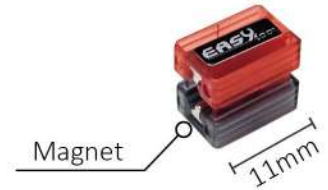

Material : ABS / N35 Magnet
Packing : Slide Card
Card Size : 70(L)x 64(W)mm
50 SETS/INNER 500 SETS/CTN 9.5/10.5KGS - 1.2'

MAX
6.35 mm
N35
MAGNET

Material : ABS / N50 Magnet
Packing : Slide Card
Card Size : 70(L)x 64(W)mm
50 SETS/INNER 500 SETS/CTN 7.5/8.5KGS - 1.2'

MAX
6.35 mm
N50
MAGNET

Material : ABS / N50 Magnet
Packing : Slide Card
Card Size : 100(L)x 35(W)mm
100 SETS/INNER 1000 SETS/CTN 10/11 KGS - 1.2'

MAX
3.0 mm
N50
MAGNET

Using Method

Auto - Adjust

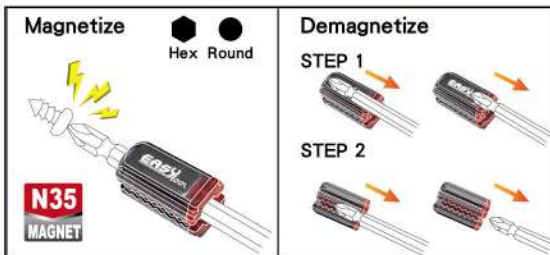

KM-1063

KM-1063A

KM-1063B

KM-1063S

KM-1063C



Mini
Magnetized Tool

6mm
Magnetized Tool

7mm
Magnetized Tool

1/4"
Hex Magnetized Tool

14.5mm
Hex Magnetized Tool

Plastic Material : PE

Plastic Material : PP

Plastic Material : ABS

Plastic Material : PP

Plastic Material : ABS

Packing : Slide Card
12SET / INNER
240 SET / CTN
13 / 14KGS - 2.5'

Packing : Slide Card
24SET / INNER
240 SET / CTN
6 / 7KGS - 1.5'

Packing : Slide Card
24SET / INNER
240 SET / CTN
6 / 7KGS - 1.5'

Packing : Slide Card
50SET / INNER
500 SET / CTN
11 / 12KGS - 1.2'

Packing : Slide Card
12 SET / INNER
240 SET / CTN
13 / 14 KGS - 2.5'

KM-2088

EXCHANGEABLE RATCHETING SCREWDRIVER



Available Sizes

SIZE	DIAMETER
+0	4.0mm
+1	5.0mm
+2	6.0mm
+3	6.0mm
-4	4.0mm
-5	5.0mm
-6	6.0mm
T15	4.0mm
T20	5.0mm
T25	6.0mm

Blade Material : S2

Plastic Material : ABS / TPR

Packing : Slide Card

10 SETS/INNER - 100 SETS/CTN - 16.5/17.5 KGS - 2.3'

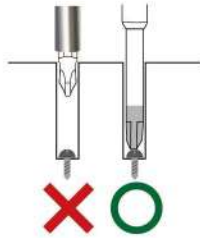

Easy Exchangeable Blades



Disc Function

KM-2088A

5-IN-1 EXCHANGEABLE RATCHETING SCREWDRIVER SET WITH POUCH



1PC - 72 Teeth ABS / TPR Handle



+ PH1 / PH2 / PH3

- 4.0 / 6.0



3-Way ratcheting function
Forward / Lock / Reverse

Blade Material : S2

Plastic Material : ABS / TPR

Packing : Slide Card

10 SETS/INNER - 30 SETS/CTN - 13.5/14.5 KGS - 2.5'



KM-2088-2

2-IN-1 EXCHANGEABLE RATCHETING SCREWDRIVER SET



1PC - 72 Teeth ABS / TPR Handle

- ⊕ PH2
- ⊖ 6.0

Blade Material : S2
Plastic Material : ABS / TPR

Packing : Slide Card
10 SETS/INNER - 80 SETS/CTN - 17.5/18.5 KGS - 2.1'

KM-2088-4

4-IN-1 EXCHANGEABLE RATCHETING SCREWDRIVER SET



1PC - 72 Teeth ABS / TPR Handle

- ⊕ PH2

Bit Standard : H1/4" x 25mm

- ⊕ PH1 / PH2
- ⊖ 6.0

Blade Material : S2
Bit Material : S2
Plastic Material : ABS / TPR

Packing : Slide Card
10 SETS/INNER - 60 SETS/CTN - 11/12 KGS - 1.5'

KM-2088-7

7-IN-1 EXCHANGEABLE RATCHETING SCREWDRIVER SET



1PC - 72 Teeth ABS / TPR Handle



- ⊕ PH2
- ⊖ 6.0

Bit Standard : H1/4" x 25mm

- ⊕ PH1 / PH2 / PH3
- ⊖ 4.0 / 6.0

Blade Material : S2
Bit Material : S2
Plastic Material : ABS / TPR

Packing : Slide Card
10 SETS/INNER - 60 SETS/CTN - 15/16 KGS - 1.9'



KM-2088B

RATCHETING SCREWDRIVER



1PC - 72 Teeth ABS / TPR Handle

Plastic Material : ABS / TPR

Packing : Bulk

KM-2088B-5

5-IN-1 EXCHANGEABLE RATCHETING SCREWDRIVER SET



1PC - 72 Teeth ABS / TPR Handle

⊕ PH1 / PH2 / PH3

⊖ 4.0 / 6.0

Bit Standard : H1/4" x 25mm

Bit Material : S2

Plastic Material : ABS / TPR

Packing : Slide Card

10 SETS/INNER - 100 SETS/CTN - 14/15 KGS - 1.8'

KM-2088C

13-IN-1 EXCHANGEABLE RATCHETING SCREWDRIVER SET



1PC - 72 Teeth ABS / TPR Handle

⊕ PH1 / PH2 / PH3

⊖ 4.0 / 6.0

Bit Standard : H1/4" x 25mm

⊕ PH1 / PH2 / PH3

⊖ 4.0 / 6.0

⊕ PZ1 / PZ2 / PZ3

Blade Material : S2

Bit Material : S2

Plastic Material : ABS / TPR

Packing : Color Sleeve

6 SETS/INNER - 18 SETS/CTN - 14.5/15.5 KGS - 1.2'

KM-2088D

6-IN-1 EXCHANGEABLE RATCHETING SCREWDRIVER SET



1PC - 72 Teeth ABS / TPR Handle



⊕ PH1 / PH2

⊖ 4.0 / 6.0

⊕ T20 / T25

Blade Material : S2

Plastic Material : ABS / TPR

Packing : Color Sleeve

6 SETS/INNER - 18 SETS/CTN - 15/16 KGS - 1.2'

KM-2053

6-IN-1 MINI SCREWDRIVER WITH RATCHET



- ⊕ PH1 / PH2 / PH3
- ⊖ 5.0 / 6.0 / 7.0



Plastic Material : ABS / PP
 Bit Standard : H1/4" x 25mmL
 Bit Material : CRV6150

Packing : Slide Card
 12 SETS/INNER - 120 SETS/CTN - 14.5/15.5 KGS - 1.9'



KM-2052

CUT-SMART DRIVER



- Wire Stripper - 0.6 / 0.8 / 1.0 / 1.3
1.6 / 2.0 / 2.6
- ⊕ PH1 / PH2 / PH3
- ⊖ 5 / 6 / 7



▲ Wire Stripper



Plastic Material : ABS / TPR
 Knife Material : K7
 Bit Standard : H1/4" x 25 mmL
 Bit Material : CRV6150

Packing : Double Blister
 12 SETS/INNER - 96 SETS/CTN - 18/19 KGS - 2.3'



KM-2060A

10-IN-1 QUICK LOADING SCREWDRIVER WITH RATCHET



1PC - 50mmL Magnetic Bit Holder

- ⊕ PH1 / PH2 / PH3
- ⊖ 4.0 / 6.0
- ⊛ T15 / T20
- S1 / S2

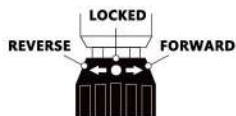

3-Way ratcheting function
 Forward / Lock / Reverse



1. To exchange a bit, pull back the handle.



2. Index arrow to desired bit in the revolving chamber.



3. Push the handle forward, and lock.



Bit Standard : H1/4" x 25mmL
 Bit Material : CRV6150
 Plastic Material : ABS / TPR / PP

Packing : Double Blister
 12 SETS/INNER - 48 SETS/CTN - 17/18 KGS - 2.4'



KM-2030

14-IN-1 EXTENDABLE SCREWDRIVER



- 1PC - Adapter
- ⊕ PH1 / PH2 / PH3
- ⊖ 5 / 6 / 7
- ⊛ T15 / T20 / T25
- 2.5 / 3.0 / 3.5

Shaft extends out 100mm for hard to reach places



Bit Standard : H1/4" x 25mmL
Bit Material : S2

Packing : Slide Card
12 SETS/INNER
48 SETS/CTN
15/16 KGS - 1.4'



KM-2076

72 TEETH RATCHET SCREWDRIVER



- 1PC - 3.5" Extension Bar
- ⊕ PH1 / PH2 / PH3
- ⊖ 5 / 6 / 7
- ⊛ T15 / T20 / T25
- 2.5 / 3.0 / 3.5



▲ Storage Handle

Bit Standard : H1/4" x 25mmL
Bit Material : S2

Packing : Slide Card
12 SETS/INNER
48 SETS/CTN
15/16 KGS - 1.4'



KM-2080

14-IN-1 EXTENDABLE 36T RATCHETING SCREWDRIVER



- 1PC - Adapter
- 1PC - 140mm Extension bar
- ⊕ PH1 / PH2 / PH3
- ⊖ 5 / 6 / 7
- ⊛ T15 / T20 / T25
- 2.5 / 3.0 / 3.5



Extension bar used for power tool

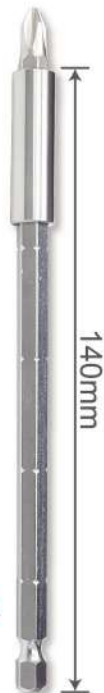

140mm



Bit Storage



Telescopic

◆ 3-Way Ratchet

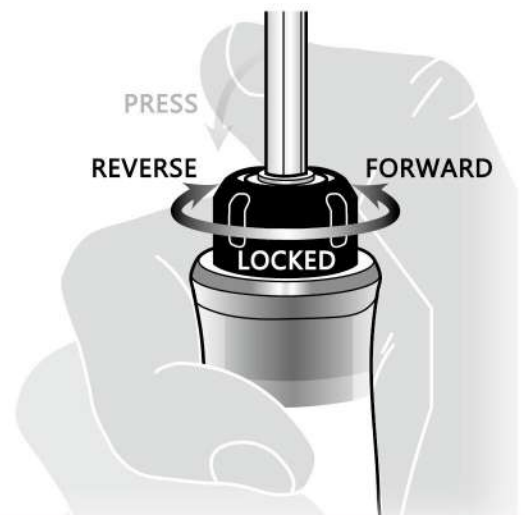

Bit Standard : H1/4" x 25mmL
Bit Material : S2

Packing : Slide Card
12 SETS / INNER - 48SETS / CTN - 14 / 15 KGS - 1.4'

KM-909 36 TEETH RATCHET ALUMINIUM HANDLE - FOR BITS



- ▲ Lightweight - 40g
- ▲ Max Torque : 65Nm
- ▲ Quick Disc Function
- ▲ 3-way Function Ratchet
- ▲ For 1/4" Bit
- ▲ Aluminium 7075

Packing : Bulk
100 SETS/INNER - 300 SETS/CTN - 12/13 KGS - 1'

KM-910 36 TEETH RATCHET ALUMINIUM HANDLE - FOR SOCKETS



- ▲ Lightweight - 42g
- ▲ Max Torque : 65Nm
- ▲ Quick Disc Function
- ▲ 3-way Function Ratchet
- ▲ For 1/4" Socket
- ▲ Aluminium 7075

Packing : Security Hang Tag (ABS)
50 SETS/INNER - 200 SETS/CTN - 10/11 KGS - 1'

KM-920 36 TEETH RATCHET ALUMINIUM HANDLE - DOUBLE ENDED



- ▲ Lightweight - 40g
- ▲ Max Torque : 65Nm
- ▲ Quick Disc Function
- ▲ 3-way Function Ratchet
- ▲ For 1/4" Bit & Socket
- ▲ Aluminium 7075

Packing : Security Hang Tag (ABS)
50 SETS/INNER - 200 SETS/CTN - 10/11 KGS - 1'

KM-36DB 36 TEETH RATCHET ZINC ALLOY HANDLE - DOUBLE ENDED



- ▲ Lightweight - 54g
- ▲ Quick Disc Function
- ▲ 3-way Function Ratchet
- ▲ For 1/4" Bit & Socket

Packing : Security Hang Tag (ABS)
50 SETS/INNER - 200 SETS/CTN - 13 /14 KGS - 1'

KM-915A GEARLESS PALM RATCHET



1/4" Bit

Packing : Hang Tag (PP)
50 SETS/INNER - 200 SETS/CTN - 19/20 KGS - 1.2'

KM-915B GEARLESS DOUBLE-ENDED PALM RATCHET



1/4" Socket x 1/4" Bit

Packing : Security Hang Tag (ABS)
50 SETS/INNER - 200 SETS/CTN - 22/23 KGS - 1.5'

KM-915C GEARLESS PALM RATCHET



1/4" Socket

Packing : Security Hang Tag (ABS)
50 SETS/INNER - 200 SETS/CTN - 22/23 KGS - 1.5'

KM-916A 72 TEETH MINI PALM RATCHET



1/4" Bit

Packing : Hang Tag (PP)
50 SETS/INNER - 200 SETS/CTN - 13/14 KGS - 1.2'

KM-916B 72 TEETH DOUBLE-ENDED MINI PALM RATCHET



1/4" Socket x 1/4" Bit

Packing : Security Hang Tag (ABS)
50 SETS/INNER - 200 SETS/CTN - 13/14 KGS - 1.2'

KM-916C 72 TEETH DOUBLE-ENDED MINI PALM RATCHET



1/4" Bit x 4mm Precision Bit

Packing : Hang Tag (PP)
50 SETS/INNER - 200 SETS/CTN - 12.5/13.5 KGS - 0.9'

KM-917A 72 TEETH PALM RATCHET



1/4" Bit

Packing : Hang Tag (PP)
50 SETS/INNER - 200 SETS/CTN - 15/16 KGS - 1.2'

KM-917B 72 TEETH DOUBLE-ENDED PALM RATCHET



1/4" Socket x 1/4" Bit

Packing : Security Hang Tag (ABS)
50 SETS/INNER - 200 SETS/CTN - 16/17 KGS - 1.3'

KM-901B

27PCS RATCHET TOOL SET



1PC - 36Teeth Double-Ended Aluminium Handle
Spline Socket - 4 / 5 / 6 / 8 / 10 / 13mm

- ⊕ PH0 / PH1 / PH2 / PH3
- ⊖ 2.0 / 3.0 / 4.0 / 5.0 / 6.0
- ⊛ T6 / T8 / T10 / T15 / T20
- 2.5 / 3.0 / 3.5
- ⊛ PZ1 / PZ2 / PZ3

Bit Material : S2
Spline Socket Material : 50BV30
Case Material : PC / ABS

Packing : Slide Card
10 SETS/INNER - 40 SETS/CTN - 13/14 KGS - 1.2'

KM-903

28PCS GEARLESS TOOL SET



1PC - Gearless Palm Ratchet
Spline Socket - 4 / 5 / 6 / 7 / 8 / 10 / 13mm
1PC - Adapter Bit

- ⊕ PH0 / PH1 / PH2 / PH3
- ⊖ 2.0 / 3.0 / 4.0 / 5.0 / 6.0
- ⊛ T6 / T8 / T10 / T15 / T20
- 2.5 / 3.0 / 3.5
- ⊛ PZ1 / PZ2

Bit Material : S2
Spline Socket Material : 50BV30
Case Material : PC / ABS

Packing : Slide Card
10 SETS/INNER - 40 SETS/CTN - 15/16 KGS - 1.2'

KM-906

32PCS MINI RATCHET TOOL SET



1PC - 72Teeth Mini Palm Ratchet
Spline Socket - 4 / 5 / 6 / 7 / 8 / 10 / 13mm
1PC - Adapter Bit

- ⊕ PH0 / PH1 / PH2 / PH3
- ⊖ 2.0 / 3.0 / 4.0 / 5.0 / 6.0
- ⊛ T6 / T8 / T10 / T15 / T20 / T25 / T27 / T30 / T35
- 2.5 / 3.0 / 3.5
- ⊛ PZ1 / PZ2

Bit Material : S2
Spline Socket Material : 50BV30
Case Material : PC / ABS

Packing : Slide Card
10 SETS/INNER - 40 SETS/CTN - 14.5/15.5 KGS - 1.2'

KM-902B

18PCS RATCHET TOOL SET



1PC - 36Teeth Double-Ended Aluminium Handle
1PC - 50mmL Stainless Bit Holder
Spline Socket - 4 / 5 / 6 / 8 / 10 / 13mm

- ⊕ PH0 / PH1 / PH2 / PH2 / PH3
- ⊖ 2.0 / 3.0 / 4.0 / 5.0 / 6.0

Bit Material : S2
Spline Socket Material : 50BV30
Case Material : PC / ABS

Packing : Slide Card
10 SETS/INNER - 40 SETS/CTN - 13/14 KGS - 1.2'

KM-905

19PCS GEARLESS TOOL SET



1PC - Gearless Palm Ratchet
Spline Socket - 4 / 5 / 6 / 7 / 8 / 10 / 13mm
1PC - Adapter Bit
1PC - 50mmL Stainless Bit Holder

- ⊕ PH0 / PH1 / PH2 / PH3
- ⊖ 2.0 / 3.0 / 4.0 / 5.0 / 6.0

Bit Material : S2
Spline Socket Material : 50BV30
Case Material : PC / ABS

Packing : Slide Card
10 SETS/INNER - 40 SETS/CTN - 15.5/16.5 KGS - 1.2'

KM-907

21PCS MINI RATCHET TOOL SET



1PC - 72Teeth Mini Palm Ratchet
Spline Socket - 4 / 5 / 6 / 7 / 8 / 10 / 13mm
1PC - Adapter Bit
1PC - 50mmL Stainless Bit Holder

- ⊕ PH0 / PH1 / PH2 / PH3
- ⊖ 2.0 / 3.0 / 4.0 / 5.0 / 6.0
- 2.5 / 3.0

Bit Material : S2
Spline Socket Material : 50BV30
Case Material : PC / ABS

Packing : Slide Card
10 SETS/INNER - 40 SETS/CTN - 13/14 KGS - 1.2'

KM-918

28PCS RATCHET TOOL SET



1PC - 72Teeth Palm Ratchet
 Spline Socket - 4 / 5 / 6 / 7 / 8 / 10 / 13mm
 1PC - Adapter Bit

- ⊕ PH0 / PH1 / PH2 / PH3
- ⊖ 2.0 / 3.0 / 4.0 / 5.0 / 6.0
- ⊛ T6 / T8 / T10 / T15 / T20
- 2.5 / 3.0 / 3.5
- ⊛ PZ1 / PZ2

Bit Material : S2
 Spline Socket Material : 50BV30
 Case Material : PC / ABS

Packing : Slide Card
 10 SETS/INNER - 40 SETS/CTN - 14/15 KGS - 1.2'



KM-919B

19PCS RATCHET TOOL SET



1PC - 72Teeth Double-Ended Palm Ratchet
 Spline Socket - 4 / 5 / 6 / 7 / 8 / 10 / 13mm
 1PC - 50mmL Stainless Bit Holder

- ⊕ PH0 / PH1 / PH2 / PH2 / PH3
- ⊖ 2.0 / 3.0 / 4.0 / 5.0 / 6.0

Bit Material : S2
 Spline Socket Material : 50BV30
 Case Material : PC / ABS

Packing : Slide Card
 10 SETS/INNER - 40 SETS/CTN - 13/14 KGS - 1.2'

KM-925

32PCS DOUBLE- ENDED MINI RATCHET TOOL SET



1PC - 70mmL Aluminium Handle
 1PC - 72 Teeth Double Ended Mini Ratchet

Bit Standard : H4 x 28mm Bit Material : 8660(SNCM)

- ⊕ PH00 / PH0
- ⊖ 1.0 / 2.0
- ⊛ T5 / T6
- ⊛ P2 / P5
- ⊙ Y1
- ▲ 2.2

Bit Standard : H1/4" x 25mm Bit Material : S2

- ⊕ PH1 / PH2 / PH3
- ⊖ 4.0 / 6.0
- ⊛ T10 / T15 / T20 / T27 / T30
- 4 / 5 / 6
- ⊛ PZ1 / PZ2 / PZ3

Precision Socket - 2.5 / 3.0 / 4.0 / 5.0

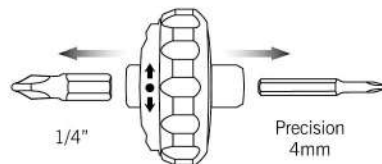

Case Material : PC / ABS

Packing : Slide Card
 10 SETS/INNER - 40 SETS/CTN - 12.5/13.5 KGS - 1.2'

KM-931

MULTI-ANGLE SCREWDRIVER WITH 36 TEETH RATCHET (FOR BIT)



1PC - 36Teeth Aluminium Handle With Universal

- ▲ For 1/4" Bit
- ▲ 180 Degrees Angle
- ▲ 3 Way Function Ratchet

Packing : Slide Card
24 SETS/INNER - 96 SETS/CTN - 11/12 KGS - 0.9'

KM-931H

MULTI-ANGLE SCREWDRIVER WITH 36 TEETH RATCHET DOUBLE-ENDED (FOR BIT & SOCKET)



1PC - 36Teeth Aluminium Handle With Universal

- ▲ For 1/4" Bit and Socket
- ▲ 360 Degrees Angle
- ▲ Quick Disc Function
- ▲ 3 Way Function Ratchet

Packing : Slide Card
24 SETS/INNER - 96 SETS/CTN - 8/9 KGS - 0.9'

KM-931HF

MULTI-ANGLE SCREWDRIVER WITH 36 TEETH RATCHET (FOR SOCKET)



1PC - 36Teeth Aluminium Handle With Universal function

- ▲ For 1/4" Socket
- ▲ 360 Degrees Angle
- ▲ Quick Disc Function
- ▲ 3 Way Function Ratchet

Packing : Slide Card
24 SETS/INNER - 96 SETS/CTN - 11/12 KGS - 0.9'

KM-931HS

MULTI-ANGLE SCREWDRIVER WITH 36 TEETH RATCHET (FOR BIT)



1PC - 36Teeth Aluminium Handle With Universal Function

- ▲ For 1/4" Bit
- ▲ 360 Degrees Angle
- ▲ Quick Disc Function
- ▲ 3 Way Function Ratchet

Packing : Slide Card
24 SETS/INNER - 96 SETS/CTN - 11/12 KGS - 0.9'

KM-932

19PCS MULTI-ANGLE SCREWDRIVER WITH 36 TEETH RATCHET TOOL SET



1PC - 36Teeth Aluminium Handle
Spline Socket - 4 / 5 / 6 / 8 / 10 / 13mm
1PC - Adapter Bit

- ⊕ PH1 / PH2
- ⊖ 4.0 / 6.0
- ⊛ T20 / T25
- 4.0 / 5.0 / 6.0
- ⊛ PZ1 / PZ2

Bit Material : S2
Spline Socket Material : 50BV30
Case Material : PC / ABS

Packing : Slide Card
10 SETS/INNER - 40 SETS/CTN - 14.5/15.5 KGS - 1.2'

KM-932H

19PCS MULTI-ANGLE SCREWDRIVER WITH 36 TEETH RATCHET TOOL SET-DOUBLE-ENDED HANDLE



1PC - 36Teeth Aluminium Handle
Spline Socket - 4 / 5 / 6 / 8 / 10 / 13mm

- ⊕ PH1 / PH2 / PH3
- ⊖ 4.0 / 6.0
- ⊛ T20 / T25
- 4.0 / 5.0 / 6.0
- ⊛ PZ1 / PZ2

Bit Material : S2
Spline Socket Material : 50BV30
Case Material : PC / ABS

Packing : Slide Card
10 SETS/INNER - 40 SETS/CTN - 13/14 KGS - 1.2'

KM-933

KM-933A

4-IN-1 TRANS DRIVER WITH 36 TEETH RATCHET



3-Way Ratchet



180 Degree Angle



Bit Storage

⊕ PH2 / PH3

⊖ 4.0 / 6.0

KM933- Aluminium Handle

KM933A- Nylon+PP Handle

Bit Material : CRV6150

Packing : Slide Card

24 SETS/INNER - 96 SETS/CTN - 13.5/14.5 KGS - 1.1'

KM-933

24 SETS/INNER - 96 SETS/CTN - 12.5/13.5 KGS - 1.1'

KM-933A



KM-933A8

12PCS TRANS DRIVER WITH 36 TEETH RATCHET

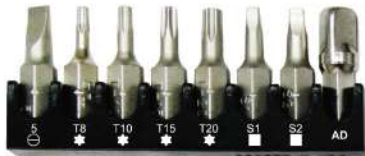

1PC - 36Teeth Nylon Handle With Universal Function

1PC - Adapter Bit

⊕ PH2 / PH3

⊖ 4.0 / 5.0 / 6.0

⊕ T8 / T10 / T15 / T20

○ S1 / S2

KM933A- Nylon+PP Handle

Bit Material : CRV6150

Bit Holder Material : PE

Packing : Slide Card

12 SETS/INNER - 72 SETS/CTN - 18/19 KGS - 0.9'

KM-933-8

12PCS TRANS DRIVER WITH 36 TEETH RATCHET

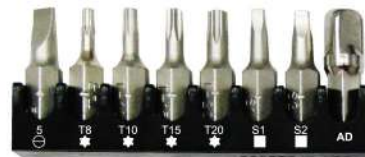

1PC - 36Teeth Aluminium Handle With Universal Function

1PC - Adapter Bit

⊕ PH2 / PH3

⊖ 4.0 / 5.0 / 6.0

⊕ T8 / T10 / T15 / T20

○ S1 / S2

KM933- Aluminium Handle

Bit Material : CRV6150

Bit Holder Material : PE

Packing : Slide Card

12 SETS/INNER - 72 SETS/CTN - 20/21 KGS - 0.9'

KM-923 12PCS 36 TEETH BICYCLE REPAIR SET WITH POUCH



- 1PC - 36Teeth Ratchet Handle
- 1PC - 50mmL Extension Bit Holder

- ⊕ PH2
- ⊖ 3.0 / 5.0
- ⊕ T25 / T30
- 3.0 / 3.5 / 4.0 / 5.0 / 6.0



Bit Material : S2
Bit Holder Material : Aluminium / CRV6150

Packing : Slide Card
12 SETS/INNER - 72 SETS/CTN - 13/14 KGS - 2.9'

KM-923T 19PCS 36 TEETH BICYCLE REPAIR TOOL SET WITH POUCH



- 1 PC-36 Teeth Double-Ended Handle With Disc
- 1 PC-50mmL Extension Bit Holder
- Spline Sockets : 4 / 5 / 6 / 7 / 8 / 10 / 13mm

- ⊕ PH2
- ⊖ 3.0 / 5.0
- ⊕ T25 / T30
- 3.0 / 3.5 / 4.0 / 5.0 / 6.0

Bit Material : S2
Bit Holder Material : Aluminium / CRV6150

Packing : Slide Card
12 SETS/INNER - SETS/CTN - 14/15 KGS - 3'

HD-01 DUAL RATCHETING SCREWDRIVER SET

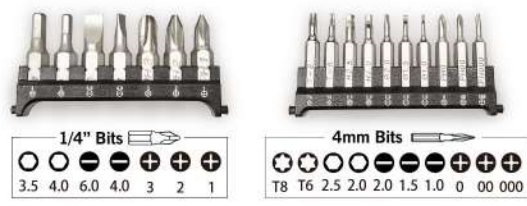

Bit Standard : H4 x 28mmL Bit Material : 8660(SNCM)
Bit Standard : H1/4" x 25mmL Bit Material : CRV6150

Packing : Slide Card
10 SETS/INNER - 60 SETS/CTN - 13.5/14.5KGS - 1.3'

KM-702-11 TWO WAY RATCHET SCREWDRIVER SET

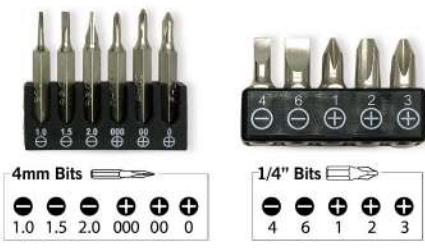

Bit Standard : H4 x 28mmL Bit Material : 8660(SNCM)
Bit Standard : H1/4" x 25mmL Bit Material : CRV6150

Packing : Slide Card
20 SETS/INNER - 100 SETS/CTN - 14/15 KGS - 1.2'



KM-929

17PCS 36 TEETH DOUBLE-ENDED RATCHET TOOL SET (FOR BIT AND SOCKET)



1PC - 36Teeth Ratchet Handle
 + PH1 / PH2 / PH2 / PH3
 - 4.0 / 6.0
 * T20 / T25
 ○ S1 / S2
 6PCS - 6PT Socket
 5.5 / 6 / 8 / 10 / 12 / 13
 Bit Material : CRV6150
 6PT Socket Material : 50BV30
 Bit Holder Material : PE

Packing : Slide Card
 12 SETS / INNER - 48 SETS / CTN - 11 / 12 KGS - 1'

KM-912

11PCS 36 TEETH RATCHET TOOL SET (FOR BIT)



1PC - 36Teeth Ratchet Handle
 + PH1 / PH2 / PH2 / PH3
 - 4.0 / 6.0
 * T20 / T25
 ○ S1 / S2
 Bit Material : S2
 Bit Holder Material : PE

Packing : Slide Card
 10 SETS / INNER - 100 SETS / CTN - 11 / 12 KGS - 0.8'

KM-930

10PCS 72 TEETH DOUBLE-ENDED PLAM RATCHET TOOL SET (FOR BIT AND SOCKET)



1PC - 72Teeth Palm Ratchet
 + PH1 / PH2 / PH3
 6PCS - 6PT Socket
 5.5 / 6 / 8 / 10 / 12 / 13
 Bit Material : CRV6150
 6PT Socket Material : 50BV30
 Bit Holder Material : PE

Packing : Slide Card
 12 SETS / INNER - 48 SETS / CTN - 10 / 11 KGS - 0.9'

KM-913

7PCS 36 TEETH RATCHET TOOL SET (FOR SOCKET)



1PC - 36Teeth Ratchet Handle
 6PCS - 6PT Socket
 5.5 / 6 / 8 / 10 / 12 / 13
 6PT Socket Material : 50BV30

Packing : Slide Card
 20 SETS / INNER - 100 SETS / CTN - 11 / 12 KGS - 1.4'

KM-915A5

6PCS GEARLESS PALM RATCHET TOOL SET



1PC - Gearless Palm Ratchet



+ PH1 / PH2 / PH3
 - 4.0 / 6.0
 Bit Material : CRV6150
 Bit Holder Material : PE

Packing : Slide Card
 20 SETS / INNER - 100 SETS / CTN - 10 / 11 KGS - 0.8'

KM-917A5

6PCS 72 TEETH PALM RATCHET TOOL SET



1PC - 72 Teeth Palm Ratchet



+ PH1 / PH2 / PH3
 - 4.0 / 6.0
 Bit Material : CRV6150
 Bit Holder Material : PE

Packing : Slide Card
 20 SETS / INNER - 100 SETS / CTN - 10 / 11 KGS - 0.8'

KM-916C9

9PCS 72 TEETH PALM RATCHET SET



1PC - 72 Teeth Double-Ended Mini Ratchet
 + PH000 / PH00 / PH0
 - 1.0 / 1.5 / 2.0
 Bit Standard : H4 x 28mm
 Bit Material : 8660(SNCM)
 Bit Holder Material : PP
 + PH1 / PH2
 - 6.0
 Bit Standard : H1/4" x 25mm
 Bit Material : CRV6150
 Bit Holder Material : PE

Packing : Slide Card
 12 SETS / INNER - 120 SETS / CTN - 12.5 / 13.5 KGS - 1.3'

KM-916A1

72 TEETH PALM RATCHET



1PC - 72Teeth Mini Palm Ratchet
⊕ PH2

Bit Material : S2

Packing : Slide Card
12 SETS/INNER - 120 SETS/CTN - 9/10 KGS - 1.2'

KM-916A4

4PCS 72 TEETH PALM RATCHET BIT SET



1PC - 72Teeth Mini Palm Ratchet
⊕ PH1 / PH2 / PH2
⊖ 6.0

Bit Material : S2
Bit Holder Material : PE

Packing : Slide Card
12 SETS/INNER - 120 SETS/CTN - 11/12 KGS - 1.2'

KM-916A6

6PCS 72 TEETH PALM RATCHET BIT SET



1PC - 72Teeth Mini Palm Ratchet
⊕ TH10 / TH15 / TH20 / TH25 / TH27 / TH30

Bit Material : S2
Bit Holder Material : PE

Packing : Slide Card
12 SETS/INNER - 120 SETS/CTN - 12/13 KGS - 1.2'

KM-927

23PCS T-HANDLE TOOL SET

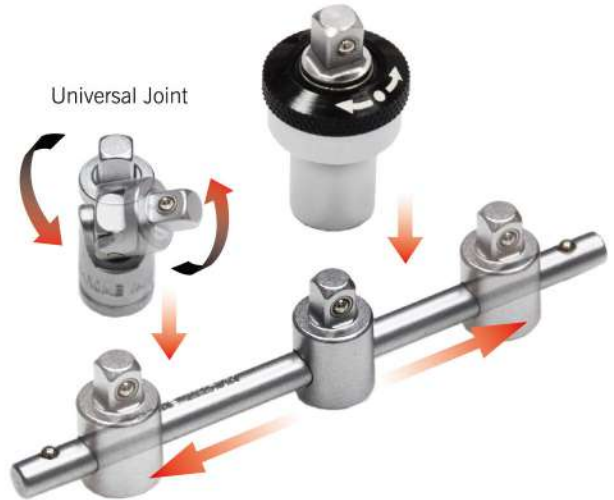

1PC - T-Handle
1PC - 36 Teeth Ratchet
Spline Socket - 5 / 6 / 8 / 10 / 12 / 13mm
1PC - Adapter
1PC - Extension Socket Holder
1PC - Universal Joint

- ⊕ PH1 / PH2 / PH3
- ⊖ 4.0 / 6.0
- ⊕ T15 / T20 / T25 / T27
- 4 / 5 / 6

Bit Material : S2
Spline Socket Material : 50BV30
Case Material : PC / ABS

Packing : Slide Card
10 SETS/INNER - 40 SETS/CTN - 17/18 KGS - 1.2'



Stubby Function



Convenient Storage Case



Extension Socket Holder



Pull Back The Handle



Select A Bit



Push Back The Handle



Select Direction Of Ratchet



KM-2016

10-IN-1 QUICK LOADING PRECISION SCREWDRIVER WITH GEARLESS RATCHET



- ⊕ PH00 / PH0 / PH1
- ⊖ 1.5 / 2.0 / 3.0
- ⊛ T5 / T6 / T8 / T10

Bit Standard : H4 x 28mmL
 Bit Material : 8660(SNCM)
 Plastic Material : PC / ABS

Packing : Double Blister
 10 SETS/INNER - 60 SETS/CTN - 8/9 KGS - 2.1'

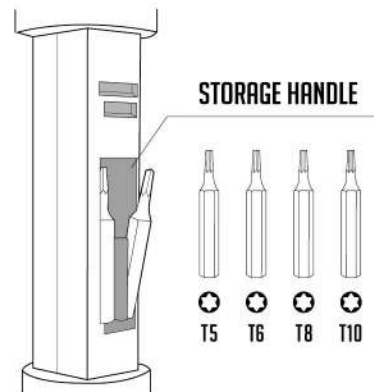

KM-2022

18-IN-1 FOLDING SCREWDRIVER WITH WRENCH



Aluminium

7pcs Screwdriver In Storage Holder



Bit Standard : H4 x 30mmL Bit Material : 8660(SNCM)

- ⊕ PH000 x ⊖ 1.5
- ⊕ PH00 x ⊖ 2.0
- ⊕ PH0 x ⊖ 2.5
- ⊛ T4 x ⊛ T8
- ⊛ T5 x ⊛ T9
- ⊛ T6 x ⊛ T10
- ⊛ T7 x ⊛ T15



Screwdriver Size : Bit Material : CRV6150

- ⊕ PH1 / ⊕ PH2 / ⊖ 5

Packing : Slide Card
 10 SETS/INNER - 100 SETS/CTN - 15/16 KGS - 2.2'



KM-2023

20-IN-1 FOLDING SCREWDRIVER WITH HEX KEY WRENCH



Hex Screwdriver

Aluminium

Bit Standard : H4 x 30mmL Bit Material : 8660(SNCM)

- ⊕ PH000 x ⊖ 1.5
- ⊕ PH00 x ⊖ 2.0
- ⊕ PH0 x ⊖ 2.5
- ⊛ T4 x ⊛ T8
- ⊛ T5 x ⊛ T9
- ⊛ T6 x ⊛ T10
- ⊛ T7 x ⊛ T15

Screwdriver Size : Bit Material : CRV6150

- 3.0 / 4.0 / 4.5 / 5.0 / 6.0

Packing : Slide Card
 10 SETS/INNER - 100 SETS/CTN - 15/16 KGS - 1.9'



KM-1075 **KM-1075A** **KM-1075P**

12-IN-1 EXTENDABLE / FLEXIBLE PRECISION SCREWDRIVER



- | | |
|-----------------|-----------------|
| ⊕ PH000 x ⊖ 1.5 | ⊕ PH000 x ⊖ 1.5 |
| ⊕ PH00 x ⊖ 2.0 | ⊕ PH00 x ⊖ 2.0 |
| ⊕ PH0 x ⊖ 2.5 | ⊗ P2 x ⊗ P5 |
| ⊗ T4 x ⊗ T8 | ⊗ T4 x ⊗ T8 |
| ⊗ T6 x ⊗ T10 | ⊗ T5 x ⊗ T9 |
| ⊗ T7 x ⊗ T15 | ⊗ T6 x ⊗ T10 |

Plastic Material : PC / PP
 Bit Standard : H4 x 30mmL Bit Material : 8660(SNCM)

Packing : Double Blister
 20 SETS/INNER - 120 SETS/CTN - 8/9 KGS - 1.4'



1075
1075P

1075A

KM-1083 **KM-1083A**

30-IN-1 EXTENDABLE / FLEXIBLE PRECISION SCREWDRIVER



- | | |
|-----------------|----------------|
| ⊕ PH000 x ⊖ 1.5 | ⊗ T4 x ⊗ T8 |
| ⊕ PH00 x ⊖ 2.0 | ⊗ T5 x ⊗ T9 |
| ⊕ PH0 x ⊖ 2.5 | ⊗ T6 x ⊗ T10 |
| ⊕ PH1 x ⊖ 3.0 | ⊗ T7 x ⊗ T15 |
| ⊗ T20 x ⊖ 1.0 | ○ H0.7x ○ H1.3 |
| ⊗ PZ0 x ⊖ 3.5 | ○ H0.9x ○ H1.5 |
| ⊗ PZ1 x ⊖ 4.0 | ○ H2.0x ○ H3.0 |
| | ○ H2.5x ○ H4.0 |

Plastic Material : PC / PE / TPR
 Bit Standard : H4 x 30mmL Bit Material : 8660(SNCM)

Packing : Double Blister
 12 SETS/INNER - 120 SETS/CTN - 13/14 KGS - 2.5'



1083

1083A

KM-2006 **KM-2006A**

30-IN-1 EXTENDABLE / FLEXIBLE PRECISION SCREWDRIVER WITH GEARLESS RATCHET



- | | |
|-----------------|----------------|
| ⊕ PH000 x ⊖ 1.5 | ⊗ T4 x ⊗ T8 |
| ⊕ PH00 x ⊖ 2.0 | ⊗ T5 x ⊗ T9 |
| ⊕ PH0 x ⊖ 2.5 | ⊗ T6 x ⊗ T10 |
| ⊕ PH1 x ⊖ 3.0 | ⊗ T7 x ⊗ T15 |
| ⊗ T20 x ⊖ 1.0 | ○ H0.7x ○ H1.3 |
| ⊗ PZ0 x ⊖ 3.5 | ○ H0.9x ○ H1.5 |
| ⊗ PZ1 x ⊖ 4.0 | ○ H2.0x ○ H3.0 |
| | ○ H2.5x ○ H4.0 |

Plastic Material : PC / PE
 Bit Standard : H4 x 30mmL Bit Material : 8660(SNCM)

Packing : Double Blister
 12 SETS/INNER - 120 SETS/CTN - 14/15 KGS - 2.5'

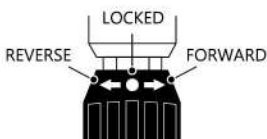

2006

2006A



KM-2003

12-IN-1 EXTENDABLE PRECISION SCREWDRIVER WITH LED LIGHT



- ⊕ PH000 x ⊖ 1.5
- ⊕ PH00 x ⊖ 2.0
- ⊕ PH0 x ⊖ 2.5
- ⊗ T4 x ⊗ T8
- ⊗ T6 x ⊗ T10
- ⊗ T7 x ⊗ T15
- 3PCS - LR41 Batteries

Plastic Material : PC / PP
 Bit Standard : H4 x 30mmL Bit Material : 8660(SNCM)

Packing : Double Blister
 12 SETS/INNER - 120 SETS/CTN - 11/12 KGS - 2.6'

KM-2017B

KM-2017

KM-2017A

16-IN-1 EXTENDABLE / FLEXIBLE GEARLESS PRECISION SCREWDRIVER



- ⊕ PH000 x ⊖ 1.5
- ⊕ PH00 x ⊖ 2.0
- ⊕ PH0 x ⊖ 2.5
- ⊗ T4 x ⊗ T8
- ⊗ T6 x ⊗ T10
- ⊗ T7 x ⊗ T15
- H0.9x ○ H1.5
- H2.0x ○ H3.0

Plastic Material : PC / PP
 Bit Standard : H4 x 30mmL Bit Material : 8660(SNCM)

Packing : Slide Card
 12 SETS/INNER - 144 SETS/CTN - 13/14 KGS - 1.9'

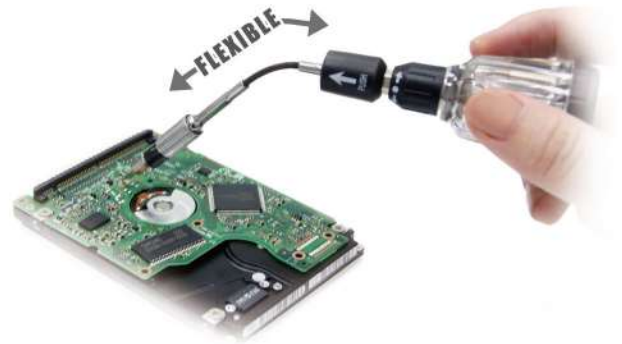

▲ 8 Useful Double-end Bits Are Stored In The Clear Swivel Bottom.

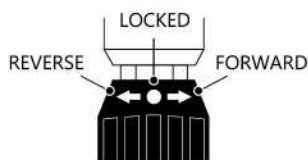

KM-2017B

KM-2017

KM-2017A

KM-2065

12-IN-1 SUPER PRECISION SCREWDRIVER SET



- ⊕ PH0000 x ⊖ 1.0
- ⊕ PH000 x ⊖ 1.5
- ⊕ PH00 x ⊖ 2.0
- ⊕ PH0 x ⊖ 2.5
- ⊕ T5 x ⊕ T8
- ⊕ T6 x ⊕ T9



Plastic Material : ABS / PC
Bit Standard : H3 x 36mmL Bit Material : 8660(SNCM)

Packing : Slide Card
24 SETS/INNER - 144 SETS/CTN - 10/11 KGS - 1.7'



KM-2065B

12-IN-1 PRECISION SCREWDRIVER SET



- ⊕ PH000 x ⊖ 1.5
- ⊕ PH00 x ⊖ 2.0
- ⊕ PH0 x ⊖ 2.5
- ⊕ T4 x ⊕ T8
- ⊕ T6 x ⊕ T10
- ⊕ T7 x ⊕ T15



Plastic Material : ABS / PC
Bit Standard : H4 x 30mmL Bit Material : 8660(SNCM)

Packing : Slide Card
24 SETS/INNER - 144 SETS/CTN - 10/11 KGS - 1.7'



KM-2078

KM-2078A

10-IN-1 MINI PRECISION SCREWDRIVER



KM-2078

- ⊕ PH0000 x ⊖ 1.0
- ⊕ PH000 x ⊖ 1.5
- ⊕ PH00 x ⊖ 2.0
- ⊕ PH0 x ⊖ 2.5
- ⊕ PH1 x ⊖ 3.0

KM-2078A

- ⊕ T4 x ⊕ T8
- ⊕ T5 x ⊕ T9
- ⊕ T6 x ⊕ T10
- ⊕ T7 x ⊕ T15
- ⊖ 2.0 x ⊕ PH00



Plastic Material : ABS / PP
Bit Standard : H3.5 x 45mmL Bit Material : 8660(SNCM)

Packing : Slide Card
12 SETS/INNER - 240 SETS/CTN - 11/12 KGS - 1.8'



KM-2059

16-IN-1 SUPER PRECISION SCREWDRIVER SET



- ⊕ PH0000 x ⊖ 1.0
- ⊕ PH000 x ⊖ 1.5
- ⊕ PH00 x ⊖ 2.0
- ⊕ PH0 x ⊖ 2.5
- ⊕ PH1 x ⊖ 3.0
- ⊕ T5 x ⊕ T8
- ⊕ T6 x ⊕ T9
- H1.5x ○ H2.5



Bit Standard : H3 x 36mmL Bit Material : 8660(SNCM)

Packing : Slide Card
24 SETS/INNER - 144 SETS/CTN - 8/9 KGS - 2.1'



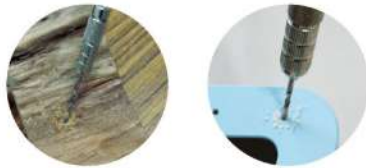
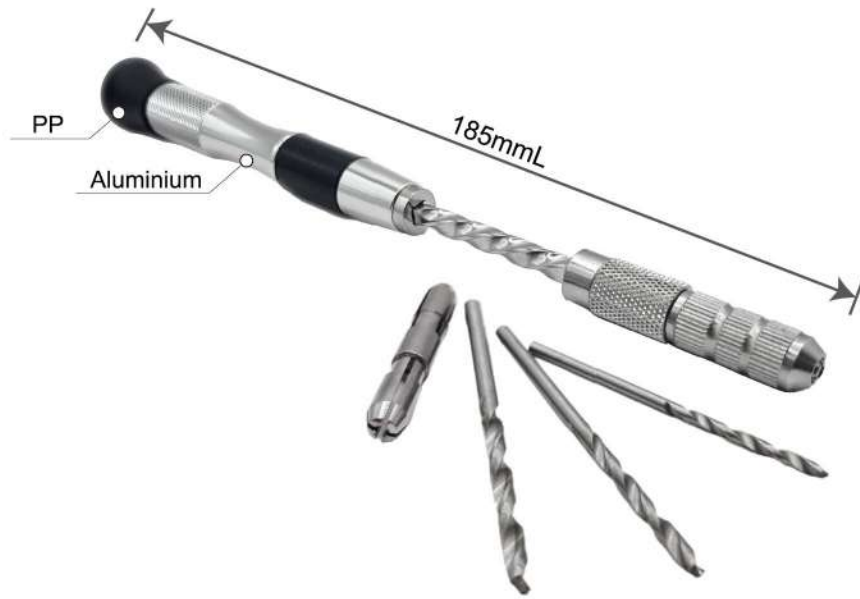

▲ For Wooden and Plastic Board.

KM-2034A

JEWELLER'S DRILL WITH DRILL SET

- 1PC - Hand Drill
- 2PCS - Pin Vises
- 3PCS - Drill Bits (2.0 / 2.5 / 3.0)

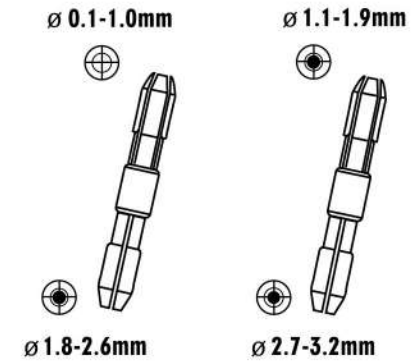

KM2034A - Aluminium Handle

Packing : Slide Card

12 SETS/INNER - 120 SETS/CTN - 12/13 KGS - 1.7'

KM-8007

4-IN-1 PRECISION SCREWDRIVER

//////

- ⊕ PH00
- ⊖ 1.8
- ⌘ Spanner
- ⦿ Pin



KM-8007

Handle Material : Brass Bit Material : 8660(SNCR)

Packing : Slide Card

24 SETS/INNER - 288 SETS/CTN - 10/11 KGS - 0.9'



KM-8008

4-IN-1 PRECISION SCREWDRIVER

//////

- ⊕ P2
- ⊖ 2.6
- ⌘ 1.4
- ⦿ 1.9



KM-8008

Handle Material : Brass Bit Material : 8660(SNCR)

Packing : Slide Card

24 SETS/INNER - 288 SETS/CTN - 10/11 KGS - 0.9'

KM-2079

5-IN-1 HOOKS WITH PICK UP TOOL



Round Angle Hook
3.5mm x 93mmL



Straight Hook
3.5mm x 83mmL



90 Degree Hook
3.5mm x 93mmL



Double Bend Hook
3.5mm x 85mmL



6 Steps Pick Up Tool
3.5mm x 175~380mmL



Storage Handle



Magnetic Pick Up



Aluminium

Hook Material : CRV6150

Packing : Slide Card

12 SETS/INNER - 96 SETS/CTN - 8/9 KGS - 1.7'



KM-2013C

7PCS HOOK & PRECISION SCREWDRIVER SET WITH POUCH

1PC - Two Color Handle (ABS / TPR)

1PC - Straight Hook

1PC - Round Angle Hook

1PC - 90 Degree Hook

1PC - 120 Degree Hook

⊕ PH0 x ⊖ 3.0

⊛ T15 x ⊛ T20



Hook Material : CRV6150
Bit Standard : H4 x 120mmL
Bit Material : 8660(SNCM)

Packing : Slide Card

20 SETS/INNER - 120 SETS/CTN - 22/23 KGS - 3.2'

20-IN-1 RC MODEL REPAIR TOOL SET

SIMPLE • CONVENIENT • FUNCTIONAL

**EXCELLENT
QUALITY**



FEATURES

- Non-slip comfortable grip handle made of ABS+TPR
- Push up to adjust the length of the bit
- Handle with 30 teeth ratchet and gearless ratchet (Two types)
- 3-Way ratcheting function Forward / Lock / Reverse
- Replacement blades available



Includes:

KM-20B7F1

Bit (H4 x 160mmL):

- ⊕ PH00 x ⊖ 2.0
- ⊕ PH0 x ⊖ 3.0
- ⊕ PH1 x ⊖ 4.0
- H1.5 x ○ H3.0
- H2.0 x ○ H3.5
- H2.5 x ○ H4.0
- 4.0 / 5.0 / 5.5 / 7.0 / 8.0

KM-20B7F2

Bit (H4 x 160mmL):

- ⊕ PH00 x ⊖ 2.0
- ⊕ PH0 x ⊖ 3.0
- ⊕ PH1 x ⊖ 4.0
- H1.5 x ○ H3.0
- H2.0 x ○ H3.5
- H2.5 x ○ H4.0
- 3.5 / 4.0 / 4.5 / 5.0 / 5.5

1PC - Two color handle with 30 teeth ratchet

1PC - Double-ended wrench 4 & 8 mm

1PC - Handy pouch

Bit Standard : H4 x 160mmL Bit Material : 8660(SNCM)

Packing : Color Box

10 SETS/INNER - 40 SETS/CTN - 15/16 KGS - 2'

KM-2087A **20-IN-1**
PROFESSIONAL TOOL SET FOR HOBBY WITH POUCH



Bit Standard : H4 x 160mmL Bit Material : 8660(SNCM)
Packing : Color Box + Color Box Size : 185.5 x 106 x 35mm
10 SETS/INNER - 40 SETS/CTN - 14.5/15.5 KGS - 2'

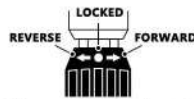

3-Way ratcheting function
Forward / Lock / Reverse

KM-2087B **19-IN-1**
PROFESSIONAL TOOL SET FOR HOBBY



Bit Standard : H4 x 160mmL Bit Material : 8660(SNCM)
Packing : Slide Card
10 SETS/INNER - 40 SETS/CTN - 16/17 KGS - 2.5'

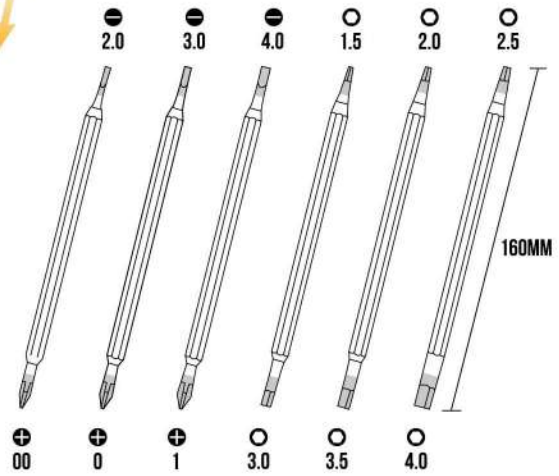
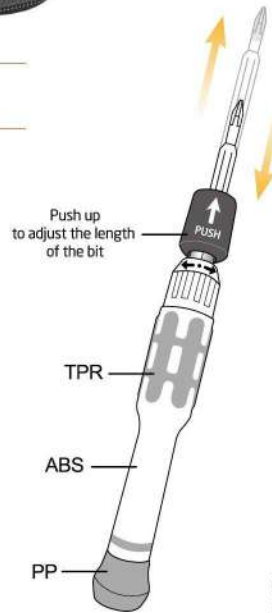
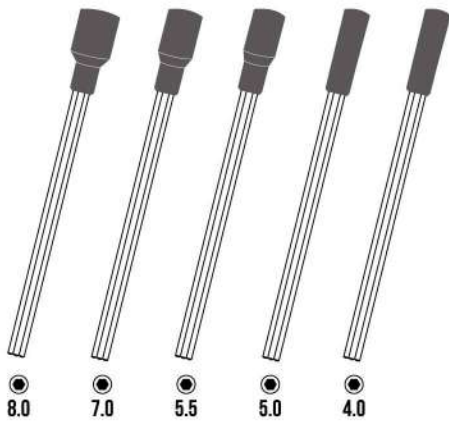

KM-2087C **12-IN-1**
PROFESSIONAL TOOL SET



⊕ PH00 x ⊖ 1.5 ⊕ T6 x ⊕ T9
⊕ PH0 x ⊖ 2.5 ⊕ T7 x ⊖ H1.5
⊕ PH1 x ⊖ 3.0 ⊕ T8 x ⊖ H2.0

Bit Standard : H4 x 120mmL Bit Material : 8660(SNCM)
Packing : Slide Card
12 SETS/INNER - 72 SETS/CTN - 14/15 KGS - 2.4'

KM-2087D **6-IN-1**
PROFESSIONAL TOOL SET



⊕ PH00 x ⊖ 1.5
⊕ PH0 x ⊖ 2.5
⊕ PH1 x ⊖ 3.0

Bit Standard : H4 x 120mmL Bit Material : 8660(SNCM)
Packing : Slide Card
20 SETS/INNER - 120 SETS/CTN - 15/16 KGS - 2.7'

HD-02 **22 PCS**
RATCHETING SCREWDRIVER SET WITH MAGNETIC CASE



Standable bit holder



115mm

H4*28mm Bit x 20pcs
8660(SNCM)
⊕ 000 / 00 / 0
⊖ 1.0 / 1.5 / 2.0 / 2.5
⊖ T4 / T5 / T6 / T8 / T10
⊖ 2.0 / 2.5 / 3.0
⊖ P2 / P5 / P6
⊖ Y0 / Y1

Bit Standard : H4 x 28mmL Bit Material : 8660(SNCM)
Packing : Slide Card
10 SETS/INNER - 60 SETS/CTN - 11.5/12.5 KGS - 1.3'

KM-2082FT 23PCS MOBILE PHONE REPAIR SET



- 1PC - 30 Teeth Ratchet Handle (ABS / TPR)
- 1PC - Metal Spudger
- 1PC - Triangle Paddle
- 1PC - Suction Pad
- 1PC - Sim Card Ejector Tool

- ⊕ PH000 / PH00 / PH0
- ⊖ 1.0 / 2.0
- ⊗ T2 / T3 / T5 / T6
- 1.3 / 1.5 / 2.0 / 2.5 / 3.0 / 4.0
- ⊕ P2 / P5
- Ⓜ Y000

Bit Standard : H4 x 28mmL Bit Material : 8660(SNCM)

Packing : Slide Card
10 SETS/INNER - 40 SETS/CTN - 8/9 KGS - 1.2'



KM-2082ET 25PCS MOBILE PHONE REPAIR SET

- 1PC - 30 Teeth Ratchet Handle (ABS / TPR)
- 1PC - Metal Spudger
- 2PCS - Plastic Pry Tool
- 1PC - Triangle Paddle
- 1PC - Suction Pad
- 1PC - Sim Card Ejector Tool

- ⊕ PH000 / PH00 / PH0
- ⊖ 1.0 / 2.0
- ⊗ T2 / T3 / T5 / T6
- 1.3 / 1.5 / 2.0 / 2.5 / 3.0 / 4.0
- ⊕ P2 / P5
- Ⓜ Y000

KM-4002T 49PCS PRECISION SCREWDRIVER SET

- 1PC - 30 Teeth Ratchet Handle (ABS / TPR)
- 1PC - Extension Bit Holder
- 1PC - Hex Magnetized Tool

Bit Standard : H4 x 28mmL Bit Material : 8660(SNCM)

- ⊕ PH000 / PH00 / PH0 / PH1 / PH2
- ⊖ 1.0 / 1.5 / 2.0 / 2.5 / 3.0 / 3.5 / 4.0
- ⊗ T4 / T5 / T6 / T7 / T8 / T9 / T10 / T15 / T20
- 0.7 / 0.9 / 1.3 / 1.5 / 2.0 / 2.5 / 3.0 / 4.0
- ⊕ PZ0 / PZ1
- Ⓜ 0 / 1
- ⊕ 1.4 / 1.8
- ⊕ 2.0 / 2.2
- S0 / S1 / S2

Precision Socket - 2.5 / 3.0 / 3.5 / 4.0 / 4.5 / 5.0

KM-4003T 26PCS PRECISION SCREWDRIVER SET

- 1PC - 30 Teeth Ratchet Handle (ABS / TPR)
- 1PC - Extension Bit Holder

Bit Standard : H4 x 28mmL Bit Material : 8660(SNCM)

- ⊕ PH000 / PH00 / PH0
- ⊖ 1.0 / 2.0
- ⊗ T2 / T3 / T5 / T6
- 1.3 / 1.5 / 2.0 / 2.5 / 3.0 / 4.0
- ⊕ P2 / P5
- Ⓜ 2.6

Precision Socket - 2.5 / 3.0 / 3.5 / 4.0 / 4.5 / 5.0

Packing : Slide Card
10 SETS/INNER - 40 SETS/CTN - 8/9 KGS - 1.2'

2082ET



Bit Standard : H4 x 28mmL
Bit Material : 8660(SNCM)

Packing : Slide Card
12 SETS/INNER - 72 SETS/CTN - 14/15 KGS - 2.4'

4002T



Bit Standard : H4 x 28mmL
Bit Material : 8660(SNCM)

Packing : Slide Card
12 SETS/INNER - 72 SETS/CTN - 19/20 KGS - 2.4'



▶ Pry Tool



▶ Suction Pad



▶ Ratchet Handle



▶ Metal Spudger



KM-2085 17-IN-1
ALUMINIUM HANDLE PRECISION SCREWDRIVER SET



- ⊕ PH000 x ⊖ 1.5
- ⊕ PH00 x ⊖ 2.0
- ⊕ PH0 x ⊖ 2.5
- ⊕ T5 x ⊕ T8
- ⊕ T6 x ⊕ T9
- 1.5 x ○ 2.5
- Ⓜ 1.8 x Ⓜ 2.6
- ⊕ P2 x ⊕ P5

Bit Standard : H4 x 100mmL Bit Material : 8660(SNCM)

Packing : Slide Card
12 SETS/INNER - 72 SETS/CTN - 12/13 KGS - 1.3

KM-2085A 17-IN-1
ALUMINIUM HANDLE PRECISION SCREWDRIVER SET WITH POUCH



- ⊕ PH000 x ⊕ P5
- ⊕ PH00 x ⊕ P2
- ⊕ PH0 x ⊖ 2.5
- ⊕ PH1 x ⊖ 3.0
- ⊕ T6 x ⊕ T9
- ⊕ T7 x ○ 1.5
- ⊕ T8 x ○ 2.0
- Ⓜ 1.8 x Ⓜ 2.6

Bit Standard : H4 x 120mmL Bit Material : 8660(SNCM)

Packing : Slide Card
12 SETS/INNER - 72 SETS/CTN - 12/13 KGS - 1.5'

KM-2085B 40-IN-1
ALUMINIUM HANDLE PRECISION SCREWDRIVER SET



- 1PC - Aluminium Handle
- 1PC - Extension Bit Holder
- 1PC - 115mmL Flexible Shaft

Bit Standard : H4 x 28mmL Bit Material : 8660(SNCM)

- ⊕ PH000 / PH00 / PH0 / PH1
- ⊖ 1.0 / 1.5 / 2.0 / 2.5 / 3.0 / 3.5 / 4.0
- ⊕ T4 / T5 / T6 / T7 / T8 / T9 / T10 / T15 / T20
- 0.7 / 0.9 / 1.3 / 1.5 / 2.0 / 2.5 / 3.0 / 4.0
- ⊕ PZ0 / PZ1

Precision Socket - 2.0 / 2.5 / 3.0 / 3.5 / 4.0 / 4.5 / 5.0 / 5.5

Packing : Slide Card
10 SETS/INNER - 40 SETS/CTN - 10/12KGS - 1.2'

KM-2085C 22-IN-1
PRECISION SCREWDRIVER SET WITH POUCH



KM-2085D



For Precision Use



Mobile Phone Repair

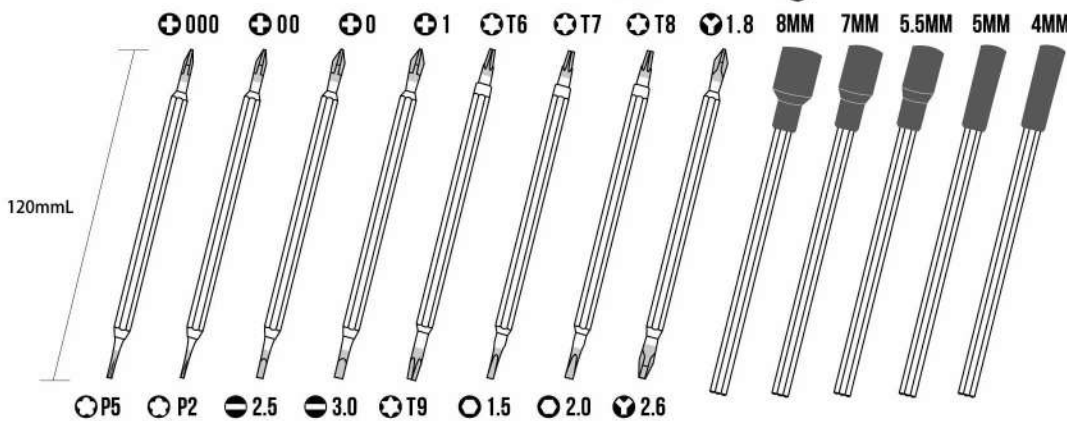

Bit Standard : H4 x 120mmL
Bit Material : 8660(SNCM)

Bit Standard : H4 x 120mmL
Bit Material : CRV6150



KM-2083 36PCS MOBILE PHONE REPAIR SET



- 1PC - Two Color Handle (ABS / TPR)
 - 1PC - Extension Bit Holder
 - 2PCS - Plastic Pry Tool
 - 1PC - Suction Pad
 - 1PC - Triangle Paddle
- Bit Standard : H4 x 28mmL Bit Material : 8660(SNCM)
- ⊕ PH000 / PH00 / PH0 / PH1
 - ⊖ 1.0 / 1.5 / 2.0 / 2.5 / 3.0 / 3.5
 - ⊛ T1 / T2 / T3 / T4 / T5 / T6 / T7 / T8 / T9 / T10 / T15
 - 1.5 / 2.0 / 2.5
 - ⦿ 2.0 / 2.2
 - ⦶ Y2.6
 - ⊗ P2 / P5 / P6

Packing : Shrink Wrap
10 SETS / INNER - 40 SETS / CTN - 10.5 / 11.5 KGS - 1.6'

KM-2082 KM-2082A 17PCS MOBILE PHONE REPAIR SET



2082

- 1PC - Two Color Handle (ABS / TPR) KM-2082
 - 1PC - Aluminium Handle KM-2082A
 - 2PCS - Plastic Pry Tool
 - 1PC - Suction Pad
 - 1PC - Triangle Paddle
- Bit Standard : H4 x 28mmL Bit Material : 8660(SNCM)
- ⊕ PH000 / PH00 / PH0
 - ⊖ 1.0 / 2.0
 - ⊛ T2 / T3 / T5 / T6
 - ⦶ Y000
 - ⊗ P2 / P5

Packing : Slide Card
12 SETS / INNER - 72 SETS / CTN - 12 / 13 KGS - 2.4'

KM-2082B KM-2082C 23PCS MOBILE PHONE REPAIR SET



2082C

- 1PC - Two Color Handle (ABS / TPR) KM-2082B
 - 1PC - Aluminium Handle KM-2082C
 - 2PCS - Plastic Pry Tool
 - 1PC - Suction Pad
 - 1PC - Triangle Paddle
- Bit Standard : H4 x 28mmL Bit Material : 8660(SNCM)
- ⊕ PH000 / PH00 / PH0
 - ⊖ 1.0 / 2.0
 - ⊛ T2 / T3 / T5 / T6
 - ⦶ Y000
 - ⊗ P2 / P5
 - 1.3 / 1.5 / 2.0 / 2.5 / 3.0 / 4.0

Packing : Slide Card
12 SETS / INNER - 72 SETS / CTN - 14 / 15 KGS - 2.4'

KM-2015 51-IN-1 PRO TECH TOOL SET

- 1PC - 80mmL Aluminium Handle
 - 1PC - Extension Bit Holder
 - 2PCS - Plastic Pry Tool
 - 1PC - Triangle Paddle
 - 1PC - Suction Pad
 - 1PC - Tweezer
 - 1PC - Metal Spudger
 - 1PC - Magnetic Parts Mat
- ⊕ PH000 / PH00 / PH0 / PH1
 - ⊖ 1.0 / 1.5 / 2.0 / 2.5 / 3.0
 - ⊛ T3 / T4 / T5
 - ⊛ TH6 / TH7 / TH8 / TH9 / TH10 / TH15
 - ⦿ 1.6 / 2.0 / 2.2 / 2.3
 - ⦶ Y0 / Y1
 - S0 / S1
 - ⦿ PIN 0.8
 - 0.9 / 1.3 / 1.5 / 2.0 / 2.5 / 3.0
 - ⊗ P2 / P5 / P6

Precision Socket - 2.5 / 3.0 / 3.5 / 4.0 / 4.5 / 5.0

Precision Bit



Bit Standard : H4 x 28mmL Bit Material : 8660(SNCM)

Packing : Color Box - Color Box Size : 202 x 106 x 45mm
12 SETS / INNER - 48 SETS / CTN - 19 / 20 KGS - 2.3'

KM-8006 **31PCS**
PRECISION SCREWDRIVER SET



1PC - 80mmL Aluminium Handle

- Bit Standard : H4 x 28mmL Bit Material : 8660(SNCM)
- ⊕ PH000 / PH00 / PH0 / PH1
 - ⊖ 1.0 / 1.5 / 2.0 / 2.5 / 3.0 / 3.5
 - ⊛ T1 / T2 / T3 / T4 / T5 / T6 / T7 / T8 / T9 / T10 / T15
 - 1.5 / 2.0 / 2.5
 - ▲ 2.0 / 2.2
 - ⦶ Y2.6
 - ⊗ P2 / P5 / P6

Packing : Slide Card
12 SETS/INNER - 72 SETS/CTN - 16/17KGS - 2.4'

KM-1077A **32PCS**
PRECISION SCREWDRIVER SET



1PC - Two Color Handle (ABS / TPR)
1PC - Extension Bit Holder

- Bit Standard : H4 x 28mmL Bit Material : 8660(SNCM)
- ⊕ PH000 / PH00 / PH0 / PH1
 - ⊖ 1.0 / 1.5 / 2.0 / 2.5 / 3.0 / 3.5 / 4.0
 - ⊛ T4 / T5 / T6 / T7 / T8 / T9 / T10 / T15 / T20
 - 0.7 / 0.9 / 1.3 / 1.5 / 2.0 / 2.5 / 3.0 / 4.0
 - ⊗ PZ0 / PZ1

Packing : Slide Card
12 SETS/INNER - 72 SETS/CTN - 16/17KGS - 2.4'

KM-1077P **KM-1077K**

KM-1077P

1PC - Two Color Handle (ABS / TPR)
1PC - Extension Bit Holder

- Bit Standard : H4 x 28mmL Bit Material : 8660(SNCM)
- ⊕ PH000 / PH00 / PH0 / PH1
 - ⊖ 1.0 / 1.5 / 2.0 / 2.5 / 3.0 / 3.5
 - ⊛ T1 / T2 / T3 / T4 / T5 / T6 / T7 / T8 / T9 / T10 / T15
 - 1.5 / 2.0 / 2.5
 - ▲ 2.0 / 2.2
 - ⦶ Y2.6
 - ⊗ P2 / P5 / P6

KM-1077K

1PC - Two Color Handle (ABS / TPR)
1PC - Extension Bit Holder

- Bit Standard : H4 x 28mmL Bit Material : 8660(SNCM)
- ⊕ PH000 / PH00 / PH0 / PH1
 - ⊖ 1.0 / 1.5 / 2.0 / 2.5 / 3.0 / 3.5
 - ⊛ T1 / T2 / T3 / T4 / T5 / T6 / T7 / T8 / T9 / T10 / T15
 - 1.5 / 2.0 / 2.5
 - ▲ 2.0 / 2.2
 - ⦶ Y2.6
 - ★ 1.4 / 1.8
 - ⊗ 1.9

Packing : Slide Card
12 SETS/INNER - 72 SETS/CTN - 16/17KGS - 2.4'

KM-1077C **32PCS**
PRECISION SCREWDRIVER SET



1PC - Aluminium Handle
1PC - Extension Bit Holder

- Bit Standard : H4 x 28mmL Bit Material : 8660(SNCM)
- ⊕ PH000 / PH00 / PH0 / PH1
 - ⊖ 1.0 / 1.5 / 2.0 / 2.5 / 3.0 / 3.5 / 4.0
 - ⊛ T4 / T5 / T6 / T7 / T8 / T9 / T10 / T15 / T20
 - 0.7 / 0.9 / 1.3 / 1.5 / 2.0 / 2.5 / 3.0 / 4.0
 - ⊗ PZ0 / PZ1

Packing : Slide Card
12 SETS/INNER - 72 SETS/CTN - 17/18 KGS - 2.4'

KM-1077E **32PCS**
PRECISION SCREWDRIVER SET



1PC - Two Color Handle (ABS / TPR)
1PC - 115mmL Flexible Shaft

- Bit Standard : H4 x 28mmL Bit Material : 8660(SNCM)
- ⊕ PH000 / PH00 / PH0 / PH1
 - ⊖ 1.0 / 1.5 / 2.0 / 2.5 / 3.0 / 3.5 / 4.0
 - ⊛ T4 / T5 / T6 / T7 / T8 / T9 / T10 / T15 / T20
 - 0.7 / 0.9 / 1.3 / 1.5 / 2.0 / 2.5 / 3.0 / 4.0
 - ⊗ PZ0 / PZ1

Packing : Slide Card
12 SETS/INNER - 72 SETS/CTN - 16/17KGS - 2.4'

KM-1077F **32PCS**
PRECISION SCREWDRIVER SET



1PC - Two Color Handle (ABS / TPR)
1PC - Extension Bit Holder

- Bit Standard : H4 x 28mmL Bit Material : 8660(SNCM)
- ⊕ PH000 / PH00 / PH0 / PH1
 - ⊖ 1.0 / 1.5 / 2.0 / 2.5 / 3.0 / 3.5 / 4.0
 - ⊛ T4 / T5 / T6 / T7 / T8 / T9 / T10 / T15 / T20
 - 0.9 / 1.3 / 1.5 / 2.0 / 2.5 / 3.0
- Precision Socket - 3.0 / 4.0 / 4.5 / 5.0

Packing : Slide Card
12 SETS/INNER - 72 SETS/CTN - 14.5/15.5 KGS - 2.4'

KM-1070A **21PCS**
PRECISION SCREWDRIVER SET



1PC - Two Color Handle (ABS / TPR)
1PC - Extension Bit Holder
1PC - 115mmL Flexible Shaft

Bit Standard : H4 x 28mmL Bit Material : 8660(SNCM)
 + PH000 / PH00 / PH0 / PH1
 - 1.0 / 1.5 / 2.0 / 2.5 / 3.0
 * T5 / T6 / T7 / T8 / T9 / T10
 O 1.5 / 2.0 / 2.5

Packing : Slide Card
12 SETS/INNER - 72 SETS/CTN - 16/17 KGS - 2.4'

KM-2057 **27PCS**
PRECISION SCREWDRIVER SET



1PC - Two Color Handle (ABS / TPR)
1PC - Extension Bit Holder
1PC - Tweezer

Bit Standard : H4 x 28mmL Bit Material : 8660(SNCM)
 + PH000 / PH00 / PH0 / PH1
 - 1.0 / 1.5 / 2.0 / 2.5 / 3.0
 * T5 / T6 / T7 / T8 / T9 / T10
 O 1.5 / 2.0 / 2.5

Precision Socket - 3.0 / 4.0 / 5.0
Drill - 1.5 / 2.0 / 2.5 Drill Material : HSS

Packing : Slide Card
12 SETS/INNER - 72 SETS/CTN - 16 /17 KGS - 2.4'

KM-1076A **39PCS**
PRECISION SCREWDRIVER SET



1PC - Aluminium Handle
1PC - Extension Bit Holder
1PC - 110mmL Flexible Shaft

Bit Standard : H4 x 30mmL Bit Material : 8660(SNCM)
 + PH000 x - 1.5 * T5 x * T9
 + PH00 x - 2.0 * T6 x * T10
 + PH0 x - 2.5 * T7 x * T15
 + PH1 x - 3.0 O H0.7x O H1.3
 * T20 x - 1.0 O H0.9x O H1.5
 * PZ0 x - 3.5 O H2.0x O H3.0
 * PZ1 x - 4.0 O H2.5x O H4.0
 * T4 x * T8

Precision Socket - 2.5 / 3.0 / 3.5
4.0 / 4.5 / 5.0

Packing : Slide Card
12 SETS/INNER - 72 SETS/CTN - 16/17 KGS - 2.4'

KM-1051A **8-IN-1**
PRECISION SCREWDRIVER SET WITH LED LIGHT



1PC - LED Handle
 + PH000 / PH00 / PH0 / PH1
 - 1.6 / 2.0 / 2.4 / 3.0

4PCS - LR41 Batteries

Bit Material : 8660(SNCM)
Bit Plastic Material : Butadine siyrene coploymer

Packing : Slide Card
12 SETS/INNER - 72 SETS/CTN - 11/12 KGS - 2.4'

KM-1051B **12-IN-1**
PRECISION SCREWDRIVER SET WITH LED LIGHT



1PC - LED Handle
 + PH000 / PH00 / PH0 / PH1
 - 1.6 / 2.0 / 2.4 / 3.0
 * T5 / T6 / T8 / T10

4PCS - LR41 Batteries

Bit Material : 8660(SNCM)
Bit Plastic Material : Butadine siyrene coploymer

Packing : Slide Card
12 SETS/INNER - 72 SETS/CTN - 12/13 KGS - 2.4'

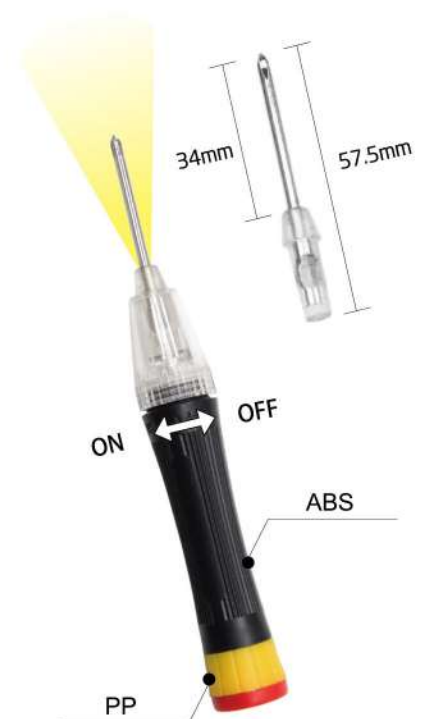

**KM-2035 27PCS
PRECISION SCREWDRIVER SET**



- 1PC - Two Color Handle (ABS / TPR)
 - 1PC - Extension Bit Holder
 - 1PC - 115mmL Flexible Shaft
 - Bit Standard : H4 x 28mmL Bit Material : 8660(SNCM)
 - ⊕ PH000 / PH00 / PH0 / PH1
 - ⊖ 1.0 / 1.5 / 2.0 / 2.5 / 3.0
 - ⊛ T5 / T6 / T7 / T8 / T9 / T10
 - 1.5 / 2.0 / 2.5
- Precision Socket - 2.5 / 3.0 / 3.5 / 4.0 / 4.5 / 5.0

Packing : Slide Card
12 SETS/INNER - 72 SETS/CTN - 17/18 KGS - 2.4'

**KM-2036 28PCS
PRECISION SCREWDRIVER SET**



- 1PC - Two Color Handle (ABS / TPR)
 - 1PC - Extension Bit Holder
 - 1PC - Tweezer
 - 1PC - Precision Hammer
 - Bit Standard : H4 x 28mmL Bit Material : 8660(SNCM)
 - ⊕ PH000 / PH00 / PH0 / PH1
 - ⊖ 1.0 / 1.5 / 2.0 / 2.5 / 3.0
 - ⊛ T5 / T6 / T7 / T8 / T9 / T10
 - 1.5 / 2.0 / 2.5
- Precision Socket - 2.5 / 3.0 / 3.5 / 4.0 / 4.5 / 5.0

Packing : Slide Card
12 SETS/INNER - 72 SETS/CTN - 19/20 KGS - 2.4'

**KM-4001 45PCS
PRECISION SCREWDRIVER SET**



- 1PC - 80mmL Aluminium Handle
 - Bit Standard : H4 x 28mmL Bit Material : 8660(SNCM)
 - ⊕ PH000 / PH00 / PH0 / PH1 / PH2
 - ⊖ 1.0 / 1.5 / 2.0 / 2.5 / 3.0 / 3.5 / 4.0
 - ⊛ T4 / T5 / T6 / T7 / T8 / T9 / T10 / T15 / T20
 - 0.7 / 0.9 / 1.3 / 1.5 / 2.0 / 2.5 / 3.0 / 4.0
 - ⊛ PZ0 / PZ1
 - ⊙ 2.0 / 2.2
 - S0 / S1 / S2
 - ⊙ Y0 / Y1
 - ⊛ 1.4 / 1.8
- Precision Socket - 2.5 / 3.0 / 4.0 / 5.0

Packing : Slide Card
12 SETS/INNER - 72 SETS/CTN - 17/18 KGS - 2.4'

**KM-2070A 21PCS
QUICK CHANGE PRECISION
SCREWDRIVER SET**



- 1PC - 120mmL Aluminium Handle
- ⊕ PH000 / PH00 / PH0 / PH1
- ⊖ 1.0 / 1.5 / 2.0 / 2.5 / 3.0 / 4.0
- ⊛ T5 / T6 / T7 / T8 / T9 / T10 / T15
- 1.5 / 2.0 / 2.5

Bit Standard : H4 x 50mmL
Bit Material : 8660(SNCM)

Packing : Slide Card
12 SETS/INNER - 72 SETS/CTN - 17/18 KGS - 2.4'



**KM-2008 27PCS
QUICK CHANGE PRECISION
SCREWDRIVER SET WITH POUCH**



- 1PC - 100mmL Aluminium Handle
 - 1PC - 115mmL Extension Bit Holder
 - Bit Standard : H4 x 50mmL Bit Material : 8660(SNCM)
 - ⊕ PH00 / PH0 / PH1 / PH2
 - ⊖ 2.0 / 3.0 / 4.0
 - ⊛ T5 / T6 / T7 / T8 / T9 / T10 / T15
- Precision Socket - 2.5 / 3.0 / 3.5 / 4.0 / 4.5 / 5.0
- Precision Spanner - 4.0 / 4.5 / 5.0 / 5.5 / 6.0

Packing : Slide Card
10 SETS/INNER - 60 SETS/CTN - 18/19 KGS - 2.7'

**KM-2008A 27PCS
QUICK CHANGE
PRECISION SCREWDRIVER SET**



- 1PC - 100mmL Aluminium Handle
 - 1PC - 115mmL Extension Bit Holder
 - Bit Standard : H4 x 50mmL Bit Material : 8660(SNCM)
 - ⊕ PH00 / PH0 / PH1 / PH2
 - ⊖ 2.0 / 3.0 / 4.0
 - ⊛ T5 / T6 / T7 / T8 / T9 / T10 / T15
- Precision Socket - 2.5 / 3.0 / 3.5 / 4.0 / 4.5 / 5.0
- Precision Spanner - 4.0 / 4.5 / 5.0 / 5.5 / 6.0

Packing : Slide Card
10 SETS/INNER - 60 SETS/CTN - 20/21 KGS - 2.7'

KM-1052 **12-IN-1**
PRECISION SCREWDRIVER SET



1PC - Precision Handle

- ⊕ PH00 x ⊖ 1.5
- ⊕ PH0 x ⊖ 2.5
- ⊕ PH1 x ⊖ 3.0
- ⊕ T6 x ⊕ T9
- ⊕ T7 x ⊖ H1.5
- ⊕ T8 x ⊖ H2.0

Bit Standard : H4 x 120mmL Bit Material : 8660(SNCM)

Packing : Slide Card
12 SETS/INNER - 72 SETS/CTN - 14/15 KGS - 2.4'

KM-1052A **12-IN-1**
PRECISION SCREWDRIVER SET



1PC - Two Color Handle (ABS / TPR)

- ⊕ PH00 x ⊖ 1.5
- ⊕ PH0 x ⊖ 2.5
- ⊕ PH1 x ⊖ 3.0
- ⊕ T6 x ⊕ T9
- ⊕ T7 x ⊖ H1.5
- ⊕ T8 x ⊖ H2.0

Bit Standard : H4 x 120mmL Bit Material : 8660(SNCM)

Packing : Slide Card
12 SETS/INNER - 72 SETS/CTN - 14/15 KGS - 2.4'



KM-1052K **12-IN-1**
PRECISION SCREWDRIVER SET



1PC - Aluminium Handle

- ⊕ PH00 x ⊖ 1.5
- ⊕ PH0 x ⊖ 2.5
- ⊕ PH1 x ⊖ 3.0
- ⊕ T6 x ⊕ T9
- ⊕ T7 x ⊖ H1.5
- ⊕ T8 x ⊖ H2.0

Bit Standard : H4 x 120mmL Bit Material : 8660(SNCM)

Packing : Slide Card
12 SETS/INNER - 72 SETS/CTN - 15.5/16.5 KGS - 2.4'

KM-1053 **6-IN-1**
PRECISION SCREWDRIVER SET



1PC - Precision Handle

- ⊕ PH00 x ⊖ 1.5
- ⊕ PH0 x ⊖ 2.5
- ⊕ PH1 x ⊖ 3.0

Bit Standard : H4 x 120mmL Bit Material : 8660(SNCM)

Packing : Slide Card
20 SETS/INNER - 120 SETS/CTN - 15/16 KGS - 2.7'

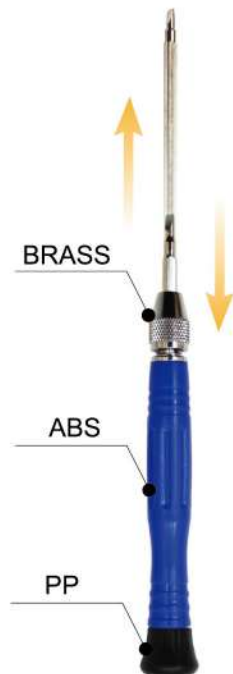

KM-2066 **28PCS**
PRECISION SCREWDRIVER SET



- 1PC - Two Color Handle (ABS / TPR)
- 1PC - Extension Bit Holder
- 1PC - 3.5 " Diagonal Cutting Plier
- 1PC - Precision Hammer
- 2PCS - Precision Hook
- 1PC - Tweezer
- 1PC - Round File

Bit Standard : H4 x 28mmL Bit Material : 8660(SNCM)

- ⊕ PH00 / PH0 / PH1
- ⊖ 1.0 / 1.5 / 2.0 / 2.5 / 3.0 / 3.5
- ⊕ T2 / T3 / T4 / T5 / T6 / T8 / T10 / T15 / T20
- ⊕ 2.2 ⊖ 2.6

Packing : Shrink Wrap
12 SETS/INNER - 48 SETS/CTN - 15/16 KGS - 1.3'



**KM-2072A 41PCS
PRECISION SCREWDRIVER SET**



- 1PC - Two Color Handle (ABS / TPR)
- 1PC - Extension Bit Holder
- 1PC - 3.5 " Diagonal Cutting Plier
- 1PC - Precision Hammer
- 1PC - Precision Hook
- 1PC - Tweezer
- 1PC - Round File
- Bit Standard : H4 x 28mmL Bit Material : 8660(SNCM)
- ⊕ PH000 / PH00 / PH0 / PH1
- ⊖ 1.0 / 1.5 / 2.0 / 2.5 / 3.0 / 3.5
- ⊕ T1 / T2 / T3 / T4 / T5 / T6 / T7 / T8 / T9 / T10 / T15
- 1.5 / 2.0 / 2.5
- △ 2.0 / 2.2
- Ⓜ Y2.6
- ★ 1.4 / 1.8
- ⊗ 1.9
- Precision Socket - 2.5 / 3.0 / 4.0 / 5.0

Packing : Slide Card
10 SETS/INNER - 40 SETS/CTN - 14/15 KGS - 2.3'

**KM-2073A 48PCS
PRECISION SCREWDRIVER SET**



- 1PC - Two Color Handle (ABS / TPR)
- 1PC - Extension Bit Holder
- 1PC - Mini Ratchet Handle
- Bit Standard : H4 x 28mmL Bit Material : 8660(SNCM)
- ⊕ PH000 / PH00 / PH0 / PH1
- ⊖ 1.0 / 1.5 / 2.0 / 2.5 / 3.0 / 3.5
- ⊕ T1 / T2 / T3 / T4 / T5 / T6 / T7 / T8 / T9 / T10 / T15
- 1.5 / 2.0 / 2.5
- △ 2.0 / 2.2
- Ⓜ Y2.6
- ★ 1.4 / 1.8
- ⊗ 1.9
- Bit Standard : H1/4" x 25mmL Bit Material : CRV6150
- ⊕ PH1 / PH2 / PH3
- ⊖ 4.0 / 6.0
- ⊕ T20 / T25
- S1 / S2 AD
- 1/4" Socket - 6 / 8 / 10 / 12 / 13 Material : AISI1008

Packing : Slide Card
10 SETS/INNER - 40 SETS/CTN - 15/16 KGS - 2.3'

**KM-2025 26PCS
PRECISION SCREWDRIVER SET**



- 1PC - Two Color Handle (ABS / TPR)
- 1PC - Extension Bit Holder
- 1PC - 3.5 " Diagonal Cutting Plier
- 1PC - Precision Hammer
- 1PC - Tweezer
- 3PCS - File (Flat / Triangle / Round)
- Bit Standard : H4 x 28mmL Bit Material : 8660(SNCM)
- ⊕ PH00 / PH0 / PH1
- ⊖ 1.5 / 2.0 / 2.5
- ⊕ T6 / T7 / T8 / T9
- 1.5 / 2.0

Precision Socket - 2.5 / 3.0 / 3.5 / 4.0 / 4.5 / 5.0

Packing : Slide Card
10 SETS/INNER - 40 SETS/CTN - 16/17 KGS - 2.5'

**KM-2018 42PCS
PRECISION SCREWDRIVER SET**



- 1PC - Two Color Handle (ABS / TPR)
- 1PC - Extension Bit Holder
- 1PC - 150mmL Flexible Shaft
- 1PC - Mini Ratchet Handle
- 1PC - Mini Extension Holder
- Bit Standard : H4 x 28mmL Bit Material : 8660(SNCM)
- ⊕ PH000 / PH00 / PH0 / PH1
- ⊖ 1.0 / 1.5 / 2.0 / 2.5 / 3.0 / 3.5 / 4.0
- 0.7 / 0.9 / 1.3 / 1.5 / 2.0 / 2.5 / 3.0 / 4.0
- Precision Socket - 2.5 / 3.0 / 3.5 / 4.0 / 4.5 / 5.0
- Bit Standard : H1/4" x 25mmL Bit Material : CRV6150
- ⊕ PH1 / PH2 / PH3
- ⊖ 4.0 / 6.0
- AD
- 1/4" Socket - 6 / 8 / 10 / 12 / 13 Material : AISI1008

Packing : Slide Card
10 SETS/INNER - 40 SETS/CTN - 20/21 KGS - 2.5'

**KM-2019 45PCS
PRECISION SCREWDRIVER SET**



- 1PC - Two Color Handle (ABS / TPR)
- 1PC - Extension Bit Holder
- 1PC - 150mmL Flexible Shaft
- 1PC - Pick Up Tool
- Bit Standard : H4 x 28mmL Bit Material : 8660(SNCM)
- ⊕ PH000 / PH00 / PH0 / PH1
- ⊖ 1.0 / 1.5 / 2.0 / 2.5 / 3.0 / 3.5 / 4.0
- ⊕ T4 / T5 / T6 / T7 / T8 / T9 / T10 / T15 / T20
- 0.7 / 0.9 / 1.3 / 1.5 / 2.0 / 2.5 / 3.0 / 4.0
- ⊗ PZ0 / PZ1
- Precision Socket - 2.5 / 3.0 / 3.5 / 4.0 / 4.5 / 5.0
- Precision Spanner - 4.0 / 4.5 / 5.0 / 5.5 / 6.0

Packing : Slide Card
10 SETS/INNER - 40 SETS/CTN - 15/16 KGS - 2.5'

**KM-2037 43PCS
PRECISION SCREWDRIVER SET**



- 1PC - Two Color Handle (ABS / TPR)
- 1PC - Extension Bit Holder
- 1PC - 150mmL Flexible Shaft
- 1PC - Mini Ratchet Handle
- 1PC - Precision Hammer
- 1PC - Precision Hook
- 1PC - Tweezer
- 1PC - Round File
- Bit Standard : H4 x 28mmL Bit Material : 8660(SNCM)
- ⊕ PH000 / PH00 / PH0 / PH1
- ⊖ 1.0 / 1.5 / 2.0 / 2.5 / 3.0
- ⊕ T5 / T6 / T7 / T8 / T9 / T10
- 1.5 / 2.0 / 2.5
- Precision Socket - 2.5 / 3.0 / 3.5 / 4.0 / 4.5 / 5.0
- Bit Standard : H1/4" x 25mmL Bit Material : CRV6150
- ⊕ PH1 / PH2 / PH3
- ⊖ 4.0 / 6.0
- AD
- 1/4" Socket - 6 / 8 / 10 / 12 / 13 Material : AISI1008

Packing : Slide Card
10 SETS/INNER - 40 SETS/CTN - 22/23 KGS - 2.5'

KM-2001 **36PCS**
PRECISION SCREWDRIVER SET



- 1PC - Two Color Handle (ABS / TPR)
- 1PC - Extension Bit Holder
- 1PC - 3.5" Diagonal Cutting Plier
- 1PC - 115mmL Flexible Shaft
- 1PC - Magnifying Glass
- 1PC - Tweezer

Bit Standard : H4 x 28mmL Bit Material : 8660(SNCM)
 + PH000 / PH00 / PH0 / PH1
 - 1.0 / 1.5 / 2.0 / 2.5 / 3.0 / 3.5 / 4.0
 + T4 / T5 / T6 / T7 / T8 / T9 / T10 / T15 / T20
 O 0.7 / 0.9 / 1.3 / 1.5 / 2.0 / 2.5 / 3.0 / 4.0
 * PZO / PZ1

Packing : Slide Card
 10 SETS/INNER - 60 SETS/CTN - 21/22 KGS - 2.7'

KM-2028 **32PCS**
PRECISION SCREWDRIVER SET



- 1PC - Two Color Handle (ABS / TPR)
- 1PC - Extension Bit Holder
- 1PC - 3.5" Diagonal Cutting Plier
- 1PC - 115mmL Flexible Shaft
- 1PC - Precision Hammer
- 1PC - Precision Hook
- 1PC - Tweezer
- 1PC - Round File

Bit Standard : H4 x 28mmL Bit Material : 8660(SNCM)
 + PH000 / PH00 / PH0 / PH1
 - 1.0 / 1.5 / 2.0 / 2.5 / 3.0 / 3.5 / 4.0
 + T4 / T5 / T6 / T7 / T8 / T9 / T10
 * PZO / PZ1
 Precision Socket - 2.5 / 3.0 / 4.0 / 5.0

Packing : Slide Card
 10 SETS/INNER - 40 SETS/CTN - 17/18 KGS - 2.5'

KM-2029 **37PCS**
PRECISION SCREWDRIVER SET



- 1PC - Two Color Handle (ABS / TPR)
- 1PC - Extension Bit Holder
- 1PC - 150mmL Flexible Shaft
- 3PCS - Precision Hook

Bit Standard : H4 x 28mmL Bit Material : 8660(SNCM)
 + PH000 / PH00 / PH0 / PH1
 - 1.0 / 1.5 / 2.0 / 2.5 / 3.0 / 3.5 / 4.0
 O 0.7 / 0.9 / 1.3 / 1.5 / 2.0 / 2.5 / 3.0 / 4.0
 Precision Socket - 2.5 / 3.0 / 3.5 / 4.0 / 4.5 / 5.0
 Precision Spanner - 4.0 / 4.5 / 5.0 / 5.5 / 6.0

Packing : Slide Card
 10 SETS/INNER - 40 SETS/CTN - 17/18 KGS - 2.5'

KM-2038 **34PCS**
PRECISION SCREWDRIVER SET



- 1PC - Two Color Handle (ABS / TPR)
- 1PC - Extension Bit Holder
- 1PC - 150mmL Flexible Shaft
- 1PC - 3.5" Diagonal Cutting Plier
- 1PC - Precision Hammer
- 2PCS - File (Triangle / Round)
- 3PCS - Precision Hook

Bit Standard : H4 x 28mmL Bit Material : 8660(SNCM)
 + PH000 / PH00 / PH0 / PH1
 - 1.0 / 1.5 / 2.0 / 2.5 / 3.0
 + T5 / T6 / T7 / T8 / T9 / T10
 O 1.5 / 2.0 / 2.5

Precision Socket - 2.5 / 3.0 / 3.5 / 4.0 / 4.5 / 5.0

Packing : Slide Card
 10 SETS/INNER - 40 SETS/CTN - 17/18 KGS - 2.5'

KM-2039 **43PCS**
PRECISION SCREWDRIVER SET



- 1PC - Two Color Handle (ABS / TPR)
- 1PC - Extension Bit Holder
- 1PC - Mini Ratchet Handle
- 2PCS - File (Triangle / Round)
- 3PCS - Precision Hook

Bit Standard : H4 x 28mmL Bit Material : 8660(SNCM)
 + PH000 / PH00 / PH0 / PH1
 - 1.0 / 1.5 / 2.0 / 2.5 / 3.0
 + T5 / T6 / T7 / T8 / T9 / T10
 O 1.5 / 2.0 / 2.5

Precision Socket - 2.5 / 3.0 / 3.5 / 4.0 / 4.5 / 5.0

Bit Standard : H1/4" x 25mmL Bit Material : CRV6150
 + PH1 / PH2 / PH3
 - 4.0 / 6.0
 AD

1/4" Socket - 6 / 8 / 10 / 12 / 13 Material : AISI1008

Packing : Slide Card
 10 SETS/INNER - 40 SETS/CTN - 22/23 KGS - 2.5'



**KM-1080A 22PCS
PRECISION SCREWDRIVER SET**



- 1PC - Two Color Handle (ABS / TPR)
- 1PC - Extension Bit Holder
- 1PC - 3.5" Diagonal Cutting Plier
- 1PC - 195mmL Flexible Shaft

Bit Standard : H4 x 28mmL
 Bit Material : 8660(SNCM)
 + PH00 / PH0 / PH1
 - 1.5 / 2.0 / 2.5
 * T6 / T7 / T8 / T9
 O 1.5 / 2.0

Precision Socket -
 2.5 / 3.0 / 3.5 / 4.0 / 4.5 / 5.0

Packing : White Box
 12 SETS/INNER
 24SETS/CTN
 7/8 KGS - 1.5'

**KM-1080C 23PCS
PRECISION SCREWDRIVER SET**



- 1PC - Two Color Handle (ABS / TPR)
- 1PC - Extension Bit Holder
- 1PC - 195mmL Flexible Shaft
- 1PC - Mini Ratchet Handle
- 1PC - Mini Extension Holder

Bit Standard : H4 x 28mmL
 Bit Material : 8660(SNCM)
 + PH00 / PH0 / PH1
 - 1.5 / 2.0 / 2.5
 * T6 / T7 / T8 / T9
 O 1.5 / 2.0

Precision Socket -
 2.5 / 3.0 / 3.5 / 4.0 / 4.5 / 5.0

Packing : White Box
 12 SETS/INNER
 24SETS/CTN
 7/8 KGS - 1.5'

**KM-1065A KM-1065H 6PCS
PRECISION SCREWDRIVER SET**



- 6PCS - Two Color Handle (ABS / TPR)

KM-1065A
 + PH00 / PH0 / PH1
 - 2.0 / 2.4 / 3.0

KM-1065H
 O 0.9 / 1.3 / 1.5 / 2.0 / 2.5 / 3.0

Bit Material : 8660(SNCM)
 Packing : Slide Card
 10 SETS/INNER - 40 SETS/CTN - 14/15 KGS - 2.5'

**KM-1065P 8PCS
PRECISION SCREWDRIVER SET**



- 8PCS - Two Color Handle (ABS / TPR)

+ PH000 / PH00
 * T5 / T6 / T8 / T10
 * P2 / P5

Bit Material : 8660(SNCM)
 Packing : Slide Card
 10 SETS/INNER - 40 SETS/CTN - 14/15 KGS - 2.3'

**KM-2010 32PCS
PRECISION SCREWDRIVER SET WITH POUCH**



▲ Convenient to carry

- 1PC - Two Color Handle (ABS / TPR)
- 1PC - Extension Bit Holder

+ PH000 / PH00 / PH0 / PH1
 - 1.0 / 1.5 / 2.0 / 2.5 / 3.0 / 3.5 / 4.0
 * T4 / T5 / T6 / T7 / T8 / T9 / T10 / T15 / T20
 O 0.7 / 0.9 / 1.3 / 1.5 / 2.0 / 2.5 / 3.0 / 4.0
 * PZ0 / PZ1

Bit Standard : H4 x 28mmL Bit Material : 8660(SNCM)
 Packing : Blister Card
 6 SETS/INNER - 48 SETS/CTN - 14/15 KGS - 2.6'

KM-2011C **47PCS**
COMPUTER ELECTRONIC TOOL SET WITH POUCH



- 1PC - Aluminium Handle
- 1PC - Extension Bit Holder
- 1PC - Magnifying Glass
- 1PC - 150mmL Flexible Shaft
- 1PC - Pickup Tool

Bit Standard : H4 x 28mmL Bit Material : 8660(SNCRM)

- ⊕ PH000 / PH00 / PH0 / PH1
- ⊖ 1.0 / 1.5 / 2.0 / 2.5 / 3.0 / 3.5 / 4.0
- ⊛ T4 / T5 / T6 / T7 / T8 / T9 / T10 / T15 / T20
- 0.7 / 0.9 / 1.3 / 1.5 / 2.0 / 2.5 / 3.0 / 4.0
- ⊛ PZ0 / PZ1

Precision Socket - 2.5 / 3.0 / 3.5 / 4.0 / 4.5 / 5.0
Precision Spanner - 4.0 / 4.5 / 5.0 / 5.5 / 6.0

Packing : Color Box • Color Box Size: 185 x 130 x 38mm
10 SETS/INNER - 40 SETS/CTN - 15/16 KGS - 1.8'

KM-2012C **48PCS**
COMPUTER ELECTRONIC TOOL SET WITH POUCH



- 1PC - Aluminium Handle
- 1PC - Extension Bit Holder
- 1PC - Magnifying Glass
- 1PC - 195mmL Flexible Shaft
- 1PC - Pickup Tool
- 1PC - 4.5" Diagonal Cutting Plier

Bit Standard : H4 x 28mmL Bit Material : 8660(SNCRM)

- ⊕ PH000 / PH00 / PH0 / PH1
- ⊖ 1.0 / 1.5 / 2.0 / 2.5 / 3.0 / 3.5 / 4.0
- ⊛ T4 / T5 / T6 / T7 / T8 / T9 / T10 / T15 / T20
- 0.7 / 0.9 / 1.3 / 1.5 / 2.0 / 2.5 / 3.0 / 4.0
- ⊛ PZ0 / PZ1

Precision Socket - 2.5 / 3.0 / 3.5 / 4.0 / 4.5 / 5.0
Precision Spanner - 4.0 / 4.5 / 5.0 / 5.5 / 6.0

Packing : Color Box • Color Box Size: 233 x 146 x 38mm
10 SETS/INNER - 40 SETS/CTN - 20/21 KGS - 2.9'

KM-1318A
SOLDER ASSIST TOOL SET

KM-13

HOOK TOOL



KM-16

KNIFE TOOL



KM-14

REAMER TOOL



KM-17

FORK TOOL



KM-15

BRUSH TOOL



KM-18

CHIP HOLDER



Plastic Material : PS KM1318A

Packing : Slide Card
24 SETS/INNER - 96 SETS/CTN - 10/11 KGS - 1.6'

Plastic Material : PS KM13-18

Packing : Slide Card
20 SETS/INNER - 240 SETS/CTN - 8 /9 KGS - 1.3'

KM-101 Series

PRECISION SCREWDRIVER

EXCELLENT QUALITY



SLOTTED

PHILLIPS

- Phillips - #000 / #00 / #0 / #1
- Slotted - 1.0 / 1.2 / 1.6 / 1.8 / 2.0 / 2.4 / 3.0

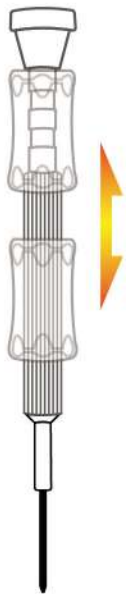

▼ **KM-101P**
Phillips Screwdriver



▼ **KM-101S**
Slotted Screwdriver



Packing : Slide Card
24 SETS/INNER
240 SETS/CTN
6/7 KGS - 1.5'

▼ **KM-101A**



- ⊕ PH00 / PH0
- ⊖ 1.0 / 1.2 / 1.8 / 2.4

Packing : Slide Card
20 SETS/INNER
80 SETS/CTN
17/18 KGS - 1.8'

▼ **KM-101**



- ⊕ PH00 / PH0
- ⊖ 1.0 / 1.2 / 1.8 / 2.4

Packing : Slide Card
20 SETS/INNER
100 SETS/CTN
16/17 KGS - 1.6'



KM-1008



⊙ 3.0/3.5/4.0/4.5/5.0

KM-1013



🔑 4.0/4.5/5.0/5.5/6.0

KM-1015

KM-1015A



⊕ PH0 / PH1
 ⊖ 1.0 / 1.2 / 1.6 / 2.0
 ⊕ PH00/PH0 / PH1
 ⊖ 1.0 / 1.2 / 1.6

KM-1031



⊕ PH000 / PH00
 ⊖ 1.0 / 1.2 / 1.4 / 1.8

KM-1005



⊕ PH0 / PH1
 ⊖ 1.4 / 2.0 / 2.4 / 3.0

KM-1003



⊕ PH0 / PH1
 ⊖ 1.4 / 2.0 / 2.4
 TWEEZER

KM-1003A



⊕ PH0 / PH1
 ⊖ 1.4 / 2.0 / 2.4
 TWEEZER

KM-1031B



⊕ PH0 / PH1
 ⊖ 1.0 / 1.2 / 1.8 / 3.5

KM-1009



⊖ 1.0 / 1.4 / 2.0 / 2.4 / 3.0 / 3.5

KM-1009A



⊕ PH0-4 / PH0-3 / PH0-2 / PH0 / PH1-2 / PH1-1

KM-1010



⊕ 3.0 / 3.5 mm
 ⊖ 1.0 / 1.4 / 2.0 / 2.4

KM-1032



⊕ PH00
 ⊖ 1.0 / 1.2 / 1.4 / 1.8

KM-1021



- ⊕ PH0-2 / PH0 / PH1-2 / PH1-1
 - ⊖ 1.0 / 1.4 / 2.0 / 2.4 / 3.0 / 3.5
 - 1.5 / 2.0 / 2.5 ● 3.0 / 4.0 / 5.0
- PRECISION AFTERBURNER ROD

KM-1038



- ⊕ T5 / T6 / T7 / T8 / T9 / T10

KM-1058



- ⊕ PH0 / PH1
- ⊖ 1.4 / 2.0 / 2.4 / 3.0

KM-1016



- ⊕ PH00 / PH0 / PH1
- ⊖ 1.0 / 1.2 / 1.4 / 1.8 / 2.4 / 3.0
- AWL / MAGNET

KM-1059



- ⊕ PH0
- ⊖ 1.6 / 2.0 / 2.4
- 2.4

KM-1035



- ⊕ PH0
- ⊖ 1.4 / 1.8

KM-1035A



- ⊕ PH000
- ⊖ 1.6



KM-1035B



- ⊕ PH00 / PH0 / PH1

KM-1041

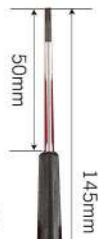

- + PH00 / PH0 / PH1
- 2.0 / 2.4 / 3.0

KM-1041T



- + T5 / T6 / T7 / T8 / T9 / T10

KM-1048

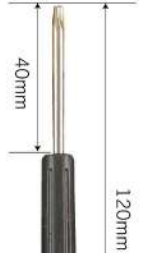

- + PH00 / PH0 / PH1
- 2.0 / 2.4 / 3.0

KM-1041-10



- + PH00 / PH0 / PH1
- 2.0 / 2.4 / 3.0
- + T5 / T6 / T8 / T10



KM-1039C



- + PH00 / PH0 / PH1
- 2.0 / 2.4 / 3.0

KM-1052F

KM-1052FT



- + PH00 / PH0 / PH1
- 1.4 / 1.8 / 2.4
- + T2 / T3 / T4 / T5 / T6 / T8

KM-1061B5



- + PH00(2.4) x 75mm
- + PH0(3.0) x 100mm
- 1.8 x 50mm
- 2.4 x 75mm
- 3.0 x 100mm

Handle Material : PP / PP
Bit Material : Carbon Steel (45C)

Packing : Slide Card
20 SETS/INNER - 120 SETS/CTN - 13/14 KGS - 1.9'

Handle Material: ABS / PP
Bit Material : 8660(SNCM)

Packing : Shrink Wrap
12 SETS/INNER - 72 SETS/CTN - 9/10 KGS - 1.7'

Handle Material: ABS / PP
Bit Material : 8660(SNCM)

Packing : Bulk
12 SETS/INNER - 72 SETS/CTN - 10/11 KGS - 1.5'

KM-P107

CARBIDE TIPPED SCRIBER



Packing : Slide Card
25 PCS/INNER - 200 PCS/CTN - 11/12 KGS - 1.5'

KM-2033

WASHER JET TOOL

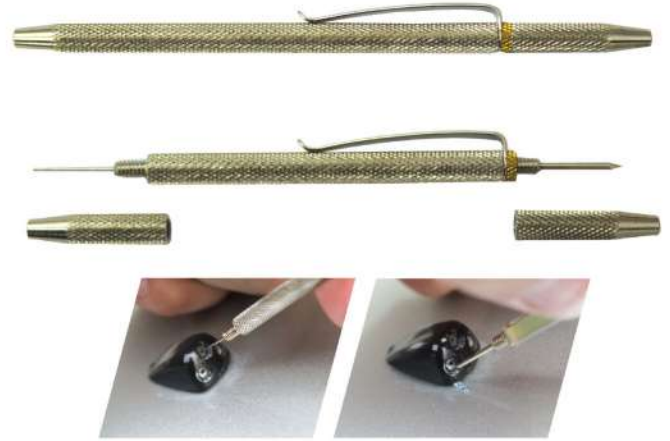

1PC - Brass Driver Handle

Packing : Slide Card
100 SETS/INNER - 500 SETS/CTN - 13/14 KGS - 1.3'

AUTOMATIC CENTER PUNCH

KM-P105

5" Punch Tool



Handle Material : Brass
Bit Material : S2

KM-P105R

5" Punch Tool
With Cap



Handle Material : Brass
Bit Material : S2
Plastic Material : ABS

KM-P105S

5" Punch Tool



Handle Material : Brass
Bit Material : S2

KM-P105RS

5" Punch Tool
With Cap



Handle Material : Brass
Bit Material : S2
Plastic Material : ABS



For Wooden Board



For Iron Board

KM-P106

6" Punch Tool



Handle Material : Brass
Bit Material : S2

KM-P106R

6" Punch Tool
With Cap



Handle Material : Brass
Bit Material : S2
Plastic Material : TPR

KM-P106S

6" Punch Tool



Handle Material : Brass
Bit Material : S2

KM-P106RS

6" Punch Tool
With Cap



Handle Material : Brass
Bit Material : S2
Plastic Material : TPR



KM-1055

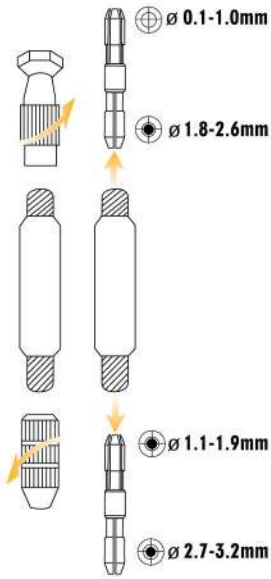

1PC - Brass Driver Handle
2PCS - Pin Vise

Packing : Slide Card
12 SETS/INNER - 240 SETS/CTN - 15/16 KGS - 1.45'

KM-1055A



1PC - Brass Driver Handle
2PCS - Pin Vise

Packing : Slide Card
12 SETS/INNER - 240 SETS/CTN - 15/16 KGS - 1.4'

KM-1055C



1PC - Brass Driver Handle
+ PH00 / PH0
- 1.5
Drill - 2.0 / 2.5 / 3.0
Drill Material : HSS
Bit Material : 8660(SNCM)

Packing : Slide Card
24 SETS/INNER - 192 SETS/CTN - 12/13 KGS - 1.2'

KM-1054



1PC - Brass Driver Handle
+ PH00 / PH0
- 1.4 / 1.8

Bit Material : 8660(SNCM)

Packing : Slide Card
20 SETS/INNER - 240 SETS/CTN - 11/12 KGS - 1.5'

TWEEZER



KM-D Series



Drill - 1.0 / 1.5 / 2.0 / 2.5 / 3.0

Handle : Carbon Steel
Drill Material : HSS

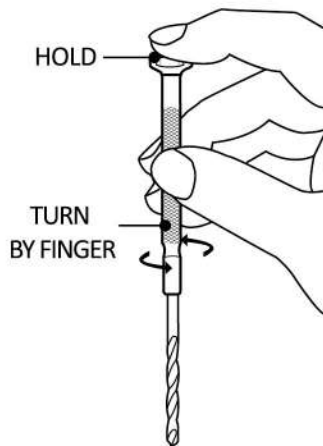

KM-Z01



+ PH1 & PH2
- 6.0

Bit Size : ø6 x 155mmL
Bit Material : CRV6150

Packing : Slide Card
24 SETS/INNER - 288 SETS/CTN - 13/14 KGS - 1.6'



Allows User To Work In Narrow Areas



Screws Do Not Drop Easily

KM-B101			<p>⊖ 3.0 x Magnet Plastic Material : PP Bit Material : 45C</p>
KM-B102			<p>⊖ 3.0 Plastic Material : PP Bit Material : 45C</p>
KM-B103			<p>⊖ 3.5 x Magnet ⊕ PH0 Plastic Material : PP Bit Material : CRV6150</p>
KM-B104			<p>⊖ 3.5 ⊕ PH0 Plastic Material : PP Bit Material : CRV6150</p>
KM-B105			<p>⊖ 3.0 ⊕ PH0(3.0) Plastic Material : PP Bit Material : 45C</p>

KM-1082

⊕ PH000 x ⊖ 1.5
 ⊕ PH00 x ⊖ 2.0
 ⊕ PH0 x ⊖ 2.5
 Bit Standard : H4 x 30mmL
 Bit Material : 8660(SNCM)

KM-1082P

Pen Clip
 ⊕ P2 / P5 / P6
 Bit Standard : H4 x 28mmL
 Bit Material : 8660(SNCM)

KM-1082A

Pen Clip
 ⊕ PH000 x ⊖ 1.5
 ⊕ PH00 x ⊖ 2.0
 ⊕ PH0 x ⊖ 2.5
 Bit Standard : H4 x 30mmL
 Bit Material : 8660(SNCM)

KEY CHAIN-01

⊕ PH000 x ⊖ 1.6
 Key-chain Material : Brass
 Bit Material : Carbon Steel 45C

PLASTIC HANDLE

<p>1 115mm</p>	<p>4 110mm</p>
<p>2 119mm</p> <p>(With Gearless Ratchet)</p>	<p>5 118mm</p> <p>(With 30 Teeth Ratchet)</p>
<p>3 113mm</p> <p>(With Gearless Ratchet)</p>	<p>6 109mm</p> <p>(With 30 Teeth Ratchet)</p>

ALUMINIUM HANDLE

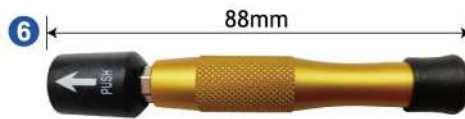

TRADITIONAL SCREWDRIVER HANDLE

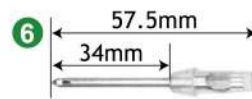
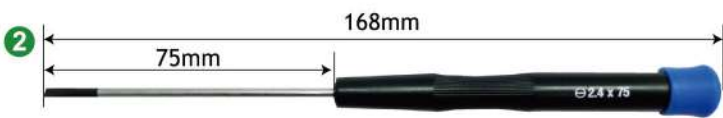
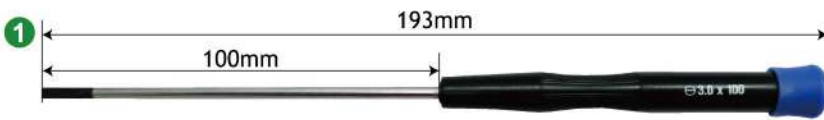

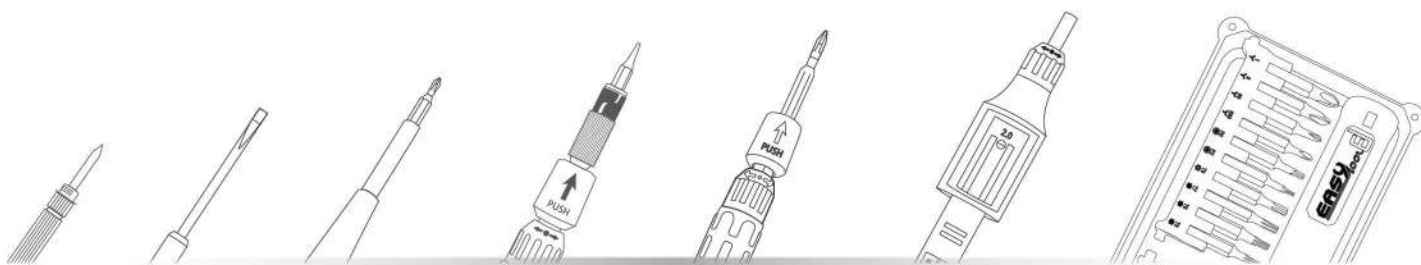

鎧鎂企業有限公司
Easy Tool Enterprise CO., LTD

📍 No.90, Sanhe Rd, Wuri Dist, Taichung City 414010, Taiwan

☎ 886-4-23382282

☎ 886-4-23376977

✉ kae.mae01@msa.hinet.net | angela@easytool.com.tw

🌐 www.kaemae.com

🌐 sales1@easytool.com.tw



OUR WEBSITE



YOUTUBE CHANNEL

